



**EFFECTIVE FROM  
JANUARY 2024**

**EXPORT CATALOGUE**  
**WHEEL ALIGNERS**  
**AND ORIGINAL ACCESSORIES**



**REL. MAY 2024**

# COLOR TABLE

- 1) The standard company colour of our equipment is blue RAL 5015 (→ /25).
- 2) On demand other colours are available (see RAL table)\*.

• Below the table for the other colors:

	→ /25 RAL 5015 Blue sky
	→ /A4 RAL 5011 Blue (Peugeot)
	→ /22 RAL 5011 Blue (Peugeot) orange-peel
	→ /16 RAL 3002 Red
	→ /45 RAL 1003 Yellow (Renault)
	→ /38 RAL 7042 Grey (Renault)
	→ /39 RAL 7040 Window grey (Volkswagen / Porsche / Fiat)
	→ /33 RAL 7011 Grey (Mercedes)
	→ /65 RAL 7012 Grey (Mercedes)
	→ /52 RAL 7015 Grey (Mercedes)
	→ /69 RAL 7030 Stone grey (Ferrari / Maserati)
	→ /34 RAL 7016 Anthracite grey (BMW)

• Different colors subject to confirmation of the Export dept.

\* : The equipment in different color than standard can be subject to surcharge.

The pictures included in the present illustrated catalogue, are only intended to show the product and are therefore not binding. The company reserves the right to make in every moment and without prior notice, any modification deemed necessary.

NEXION S.p.A. declines any responsibility for any complaint coming from the use of not original accessories or spares with consequent forfeiture of the CE conformity declaration.

# TABLE OF CONTENTS

<b>PRE-CHECK DRIVE-THROUGH</b>	<b>4</b>
ICHECK 2GO	4
ICHECK 3.5 TOP	5
ICHECK 3.5 F.A.S.T & FULL	6
COMPULSORY ACCESSORIES FOR ICHECK	7
OPTIONAL ACCESSORIES FOR ICHECK	8
IPROFILE	16
OPTIONAL ACCESSORIES FOR IPROFILE STANDALONE	17
<b>CAMERA WHEEL ALIGNERS</b>	<b>19</b>
C2000 NÉOS	19
C 880 INEXT	20
C 880	21
C 880 W	22
C 880 INEXT DRIVE	23
COMPULSORY ACCESSORIES FOR C 880 INEXT DRIVE	24
OPTIONAL ACCESSORIES FOR CAMERA WHEEL ALIGNERS	25
<b>RADIO/CCD WHEEL ALIGNERS</b>	<b>39</b>
C 500 1.1	39
C 500 1.1 ROAD TRUCK	40
OPTIONAL ACCESSORIES FOR C 500 1.1 ROAD TRUCK	41
C 400 INEXT	42
C 200 INEXT	43
C 200 ROAD	44
C 200 INEXT SMART	45
OPTIONAL ACCESSORIES FOR C 200 ROAD AND C 200 INEXT SMART	46
OPTIONAL ACCESSORIES FOR "C" SERIES	48
UPGRADE TO ALIGNER DATA BANK	64
DIAGRAM OF PACKING SPECIFICATION	65
GENERAL SALE CONDITIONS	67



 : New or Modified Item



# PRE-CHECK DRIVE-THROUGH



**iCheck 2go**  
Vehicle Dynamics Quick Check



Dynamic pre-check during passing  
quick check of the vehicle  
for cars and light commercial vehicles

Analyze the forces exerted while driving  
predicts tire wear



**MODEL SUPPLIED WITH:**

- 1 Control unit with PC Mini ITX, multimedial mini-keyboard and trackball.
- 2 Contact-less measuring unit for front and/or rear axle.
- 1 Operator's manual

## ICHECK 2GO

PN	Power Supply	Description
0-35101101/25	100-240Vac / 1 Ph / 50-60Hz	<b>iCheck 2go Full Pack:</b> includes central unit with cabinet, PC, keyboard, mouse, processing system, measuring platforms for recessed installation and traffic light.
0-35101201/25	100-240Vac / 1 Ph / 50-60Hz	<b>iCheck 2go KIT:</b> includes the processing system, measurement platforms for recessed installation and traffic light
8-35200003		<b>Customization kit</b> to be ordered with iCheck 2go: includes software, user manuals, customization items (compulsory)



: New or Modified Item



# PRE-CHECK DRIVE-THROUGH

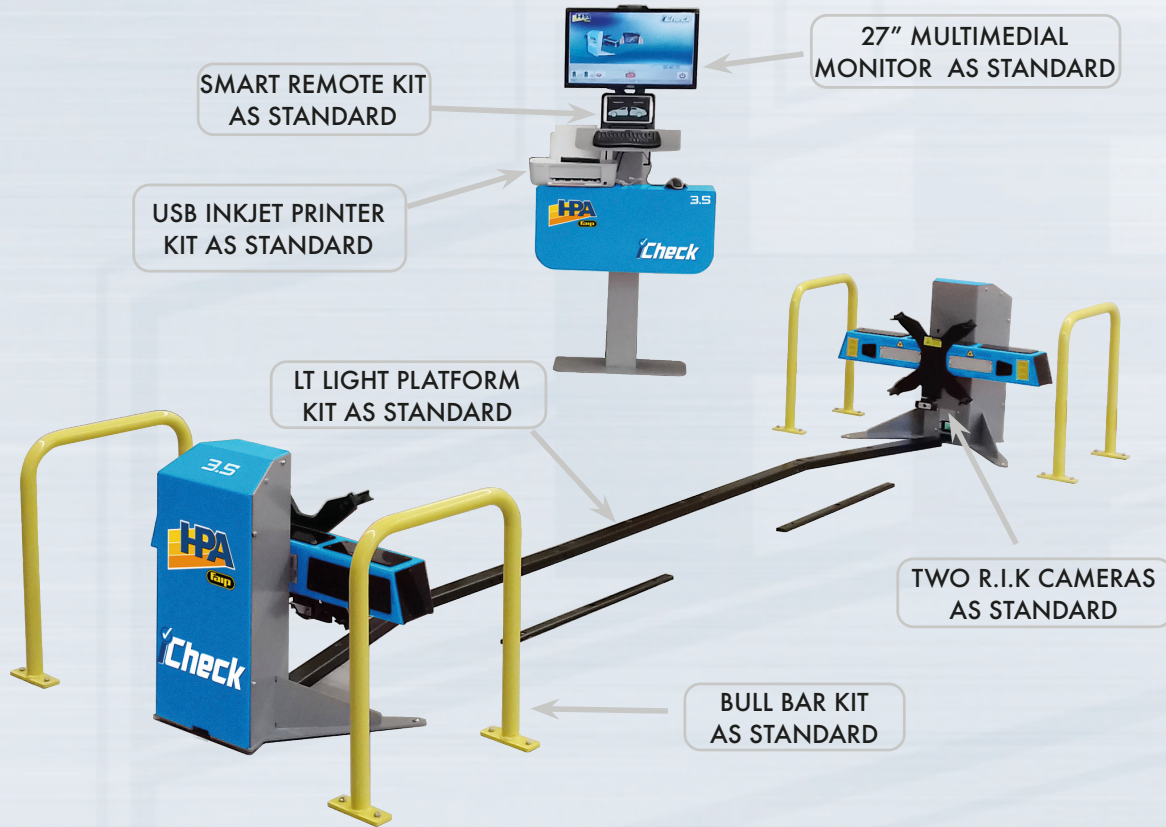

**MODEL SUPPLIED WITH:**

- 1 Control unit with PC Mini ITX, multimedial mini-keyboard and trackball.
- 2 Contact-less measuring unit.
- 1 Multimedial 27" Monitor
- 1 LT light platform kit
- 2 Bull bar kit
- 1 RIK (Rim Imaging Kit)
- 1 Smart remote
- 1 USB inkjet printer
- 1 Operator's manual

## ICHECK 3.5 TOP

PN	Power Supply	Description
0-35200301/25	115-230V/1Ph/50-60Hz	<b>iCHECK 3.5 TOP</b> - Version for front and rear axle measurement (FULL OPTIONAL version)



: New or Modified Item

# PRE-CHECK DRIVE-THROUGH



**iCheck**  
3.5



**F.A.S.T.**  
FRONT AXLE SCAN TECHNOLOGY



**F.A.S.T. & FULL**

27" MULTIMEDIA MONITOR ON REQUEST



LT LIGHT PLATFORM KIT ON REQUEST

BULL BAR KIT ON REQUEST



**MODEL SUPPLIED WITH:**

- 1 Control unit with PC Mini ITX, multimedial mini-keyboard and trackball.
- 2 Contact-less measuring unit for front and/or rear axle.
- 1 Operator's manual



## ICHECK 3.5 F.A.S.T & FULL

PN	Power Supply	Description
0-35200101/25	115-230V/1Ph/50-60Hz	<b>iCHECK 3.5 F.A.S.T.</b> - Basic version for measuring the front axle only.
0-35200201/25	115-230V/1Ph/50-60Hz	<b>iCHECK 3.5 FULL</b> - Full version for front and rear axle measurement.

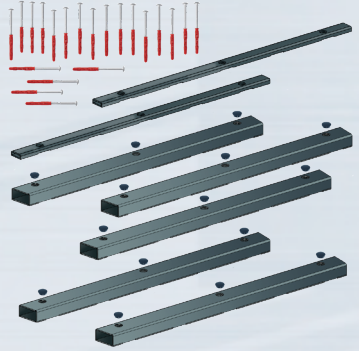

: New or Modified Item

# COMPULSORY ACCESSORIES FOR ICHECK



PN	Picture	Description	iCHECK 2 Go	iCHECK 3.5 FULL	iCHECK 3.5 FAST
8-34100016		<b>27"</b> LCD Multimedial monitor with integrated webcam	■	●	●
8-35100018		<b>LT Light platform kit.</b> * In drive-thru solution for passage car purpose. Comprising: - 5 Front platforms - 2 Rear platforms - 15 Caps Heyco D.23 mm - 21 Masonry screws 10 x 60 mm *: please refer to illustration in previous page for correct positioning of platform kit	■	●	●
8-35100010		<b>Masonry screws kit</b> for runways in case of compact concrete or underfloor heating (18 pcs.).	●	●	●
8-35100009		<b>Masonry screws kit</b> for runways in case of standard floor (18 pcs.).	●	●	●



## OPTIONAL ACCESSORIES FOR ICHECK

PN	Picture	Description	iCHECK 2 Go	iCHECK 3.5 TOP	iCHECK 3.5 FULL	iCHECK 3.5 FAST
8-34120000		<b>27"</b> LCD monitor	●			
8-61200143		<b>LCD</b> monitor support	●			
8-61200237		A4 colour inkjet <b>printer</b> unit	●			
8-35100086		<b>Wireless remote control kit</b> (with 2.4 GHz industrial radio)	●			
8-31100001		<b>NEXREMOTE</b> Basato su un tablet SAMSUNG, può essere utilizzato come comando a distanza e/o come schermo supplementare. Composto da: - 1 Tablet SAMSUNG + 1 Protezione in gomma - 1 Router WI-FI	●			

## OPTIONAL ACCESSORIES FOR ICHECK



PN	Picture	Description	iCHECK 2 Go	iCHECK 3.5 TOP	iCHECK 3.5 FULL	iCHECK 3.5 FAST
8-35100084		<b>Ramp kit</b> for floor installation	●			
8-35100088		<b>Booking service</b> enabling kit	●			
8-35100093		<b>Pre-check databank updating kit</b> - iCHECK 2 Go	●			

# OPTIONAL ACCESSORIES FOR ICHECK



PN	Picture	Description	iCHECK 3.5 TOP	iCHECK 3.5 FULL	iCHECK 3.5 FAST
8-35100003		<p><b>Bull bar kit</b> The kit consists of two steel protection bars, which is sufficient for one side only.</p>	■	●	●
8-35100014		<p><b>122 Kit</b> Software and hardware to transform the iCHECK from one axle measurement to two axle measurement, F.A.S.T. to FULL. The upgrade is retrofittable and consists of:</p> <ul style="list-style-type: none"> <li>- software upgrade,</li> <li>- protection key activation program,</li> <li>- steering electronic level for straight vehicle drive on.</li> </ul>			●
8-35100016		<p><b>Smart remote</b> Based on a SAMSUNG tablet, can be used as a remote control and an additional screen.</p> <p>Comprising:</p> <ul style="list-style-type: none"> <li>-1 Dedicated APP.</li> <li>-1 SAMSUNG Tablet + 1 Rubber protection cover.</li> <li>-1 Special power supply connection.</li> </ul>	■	●	●

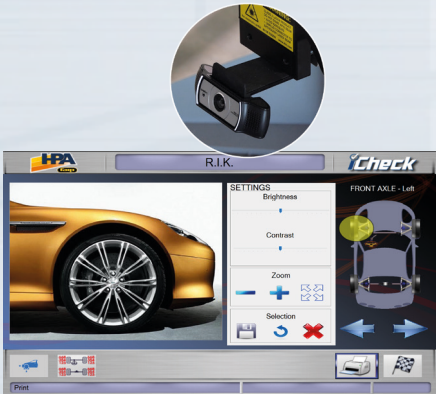

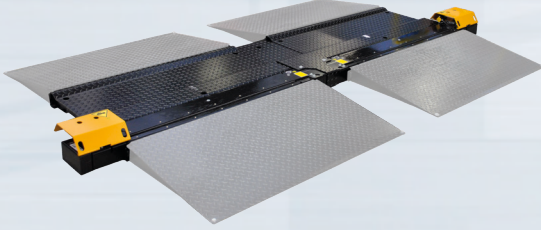
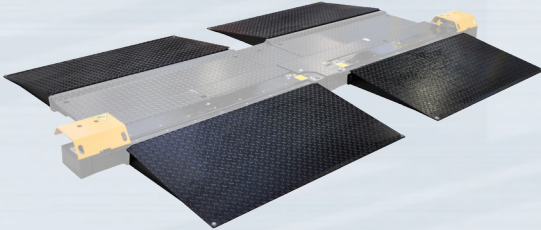

# OPTIONAL ACCESSORIES FOR ICHECK

PN	Picture	Description	iCHECK 3.5 TOP	iCHECK 3.5 FULL	iCHECK 3.5 FAST
8-35100017		<p><b>RIK (Rim Imaging Kit)</b>            During the pre-check you can take a high definition snap-shot of the rim, and save it according to the plate number or customer name.            RIK images are in color, for a better detection of scratches or damages on the rim; more over the Drive on Assistant will be activated together with RIK, to quickly position the wheel for the test.</p>	■	●	●
8-21120005		<p><b>USB inkjet printer kit.</b>            Available only for shipment from Italy</p>	■	●	●
8-35100005		<p><b>1.5 Calibration set</b>            Comprising:            -Offset Bar.            -Calibration Target.            -Calibration Laser.            -Magnetizing Digital Level.            -Drawn Alloy Bars            -Rubber pads.</p>	●	●	●

# OPTIONAL ACCESSORIES FOR ICHECK

PN	Picture	Description	iCHECK 3.5 TOP	iCHECK 3.5 FULL	iCHECK 3.5 FAST	
8-3520001		<p><b>iPROFILE</b>                      Device for automatic tyre tread depth measurement with a double laser scanning system. Simple, easy and accurate. Perfect integration with iCHECK. 3.5. Ready for flush installation. Ramps NOT included</p>	●	●	●	
8-35100021		<p><b>Set of ramps for iPROFILE</b>                      Suitable for on-floor installation.</p>	●	●	●	
8-35100026	<p><b>LAUNCHER</b>                      PRECHECK</p>  <p>PROTECTION                      SAFETY                      LOYALTY                      PROFITABILITY</p>	<p><b>LAUNCHER PRECHECK</b> 2x IPCam for Visual Check Included                      Software management package for car pre-check:</p> <ul style="list-style-type: none"> <li>- Wheel alignment check-up</li> <li>- Tyre consumption check</li> <li>- Battery efficiency check</li> <li>- Headlight integrity check</li> <li>- State of TMPS sensor</li> <li>- Various internal and external visual inspections</li> <li>- Customer databank</li> <li>- etc.</li> </ul>		●	●	●

# OPTIONAL ACCESSORIES FOR ICHECK

PN	Picture	Description	iCHECK 3.5 TOP	iCHECK 3.5 FULL	iCHECK 3.5 FAST
8-35100029	 <p><b>LAUNCHER</b> AUTO QR</p> <p>HPA Group</p> <p>SERVICE GOMME Via M. Polo, 4 Prato di Correggio (RE) 0522 747999</p>	<p><b>LAUNCHER AUTO QR</b> 2x IPCam for Visual Check Included Software management package + QR code system software. Data input (first time only). -QR code sticker print out. -Automatic recall by smartphone or tablet. -Visibility of workshop information. -Data upload. -Tablet and smartphone dedicated APP.</p>	●	●	●
8-35100067	 <p><b>AUTO QR</b></p>	<p><b>AUTO QR UPDATE</b> Kit for updating LAUNCHER PRECHECK (PN. 8-35100026) to LAUNCHER AUTO QR (PN. 8-35100029).</p>	●	●	●

## Available Management Configurations:

### Management packages

Model	Launcher	Auto QR	Front/Rear Webcam	QR Code Printer	TPMS	Head light tester
8-35100026	STD	NA	STD	NA	OPT	OPT
8-35100029	STD	STD	STD	STD	OPT	OPT



STD: Item supplied in the configuration.

NA: Item not available in the configuration.

OPT: Item supplied on request in the configuration.

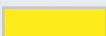
 : New or Modified Item



# OPTIONAL ACCESSORIES FOR ICHECK

PN	Picture	Description		iCHECK 3.5 TOP	iCHECK 3.5 FULL	iCHECK 3.5 FAST
8-35100065		Wireless <b>QR Code scanner</b>		●	●	●
8-35100030		<p><b>Camera head light tester</b> LASER Alignment. Trolley mounted version.</p> <p><u>Perfect integration with iCHECK 3.5 with LAUNCHER PRECHECK or LAUNCHER PRECHECK &amp; AUTO QR software.</u></p>		●	●	●

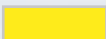

 : New or Modified Item

# OPTIONAL ACCESSORIES FOR ICHECK

PN	Picture	Description	iCHECK 3.5 TOP	iCHECK 3.5 FULL	iCHECK 3.5 FAST
6015001300		<b>TPM-02 TPMS Diagnostic Tool</b> Perfect integration with iCHECK 3.5 with LAUNCHER PRECHECK or LAUNCHER PRECHECK & AUTO QR software.	●	●	●
8-51100029		<b>TPM-02</b> standard annual subscription.	●	●	●
8-51120003		<b>TPM-02</b> extended annual subscription.	●	●	●
8-35100068		<b>External USB-Hard Drive</b> 1 TB to locally store the LAUNCHER results.	●	●	●
8-35100069		<b>Data Bank</b> update kit.	●	●	●
8-35100071		U.S.A. <b>Data Bank</b> enable kit	●	●	●

# PRE-CHECK DRIVE-THROUGH



IPROFILE KIT

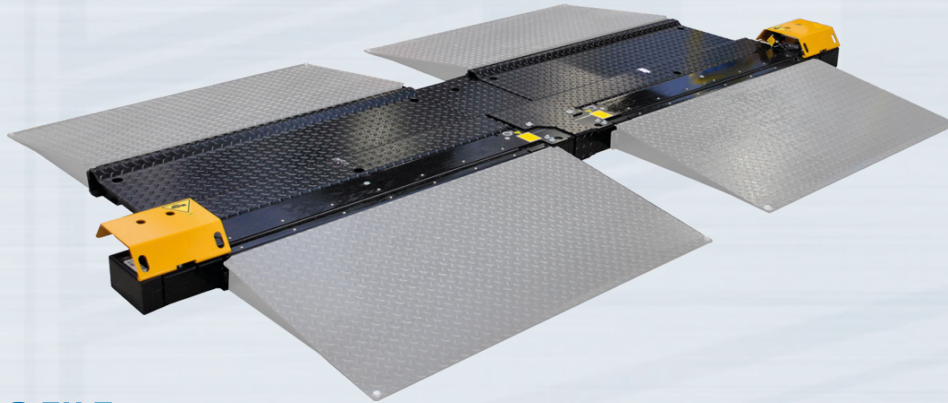

iPROFILE FULL PACK

## IPROFILE FULL PACK

### MODEL SUPPLIED WITH:

- 1 Profilometer
- 1 Cabinet
- 1 Electrical system interface between Profilometer and PC
- 1 64-Bit Windows 10 Embedded PC, license and recovery USB flash drive
- 1 Trackball mouse
- 1 USB printer
- 1 Operator's manual

## iPROFILE

PN	Power Supply	Description
0-35100601/39	100-240V/1Ph/50-60Hz	<b>iPROFILE</b> - Standalone full pack for flush installation.
0-35100701	100-240V/1Ph/50-60Hz	<b>iPROFILE Kit</b> - Standalone electrical panel kit for flush installation
8-35200002		<b>iPROFILE</b> Standalone customization kit (compulsory).



: New or Modified Item



## OPTIONAL ACCESSORIES FOR IPROFILE STANDALONE

PN	Picture	Description	iPROFILE FULL	iPROFILE KIT
8-35100021		<b>Set of ramps</b> for iPROFILE. Suitable for on-floor installation.	●	●
8-35100061		<b>Management Package software:</b> <ul style="list-style-type: none"> <li>- Customer Database</li> <li>- Storage of all contact information of Customers.</li> <li>- Digital archive of the tests performed, with the possibility to retrieve tests.</li> <li>- Messaging system for customer-focused notifications. Direct contact with Customer through Whatsapp (it requires an Internet connection).</li> </ul>	●	●
8-34120000		<b>27"</b> LCD monitor	●	●

# OPTIONAL ACCESSORIES FOR IPROFILE STANDALONE

PN	Picture	Description		IPROFILE FULL	IPROFILE KIT
8-61200143		LCD monitor support.		●	
8-61200237		A4 colour inkjet <b>printer</b> set - USB connection.		■ ●	
8-33100078		Optical <b>mouse</b> kit.		■ ●	

# CAMERA WHEEL ALIGNERS



## C2000 néos



Monitor  
NOT included

Trolley  
NOT included



### MODEL SUPPLIED WITH:

- Column
- PC
- Keyboard
- Mouse
- 4 targets with sun-filter
- Steering wheel holder
- Pedal depressor

## C2000 NÉOS

PN	Power Supply	Description
0-34103001/49	100-240Vac/1Ph/50-60Hz	<b>C2000 Nèos FULL PACK:</b> Four Hi-Q digital camera for machine vision, suitable for any wheel clamp. Provided with measuring beam, column, PC, keyboard, mouse, 4 hi-resolution light targets with anti-reflective filter, steering wheel lock, brake depressor. LCD Display, printer, wheel clamps and turntables not included. NEW "ROC SMART" FUNCTION INCLUDED.
8-34900089/25		<b>Customization kit</b> to be ordered with C2000 Nèos: alignment software, user manuals, customization items (compulsory)



  : New or Modified Item



# CAMERA WHEEL ALIGNERS



## C 880 iNEXT



Monitor  
NOT included

Clamps  
NOT included

### C 880 iNEXT

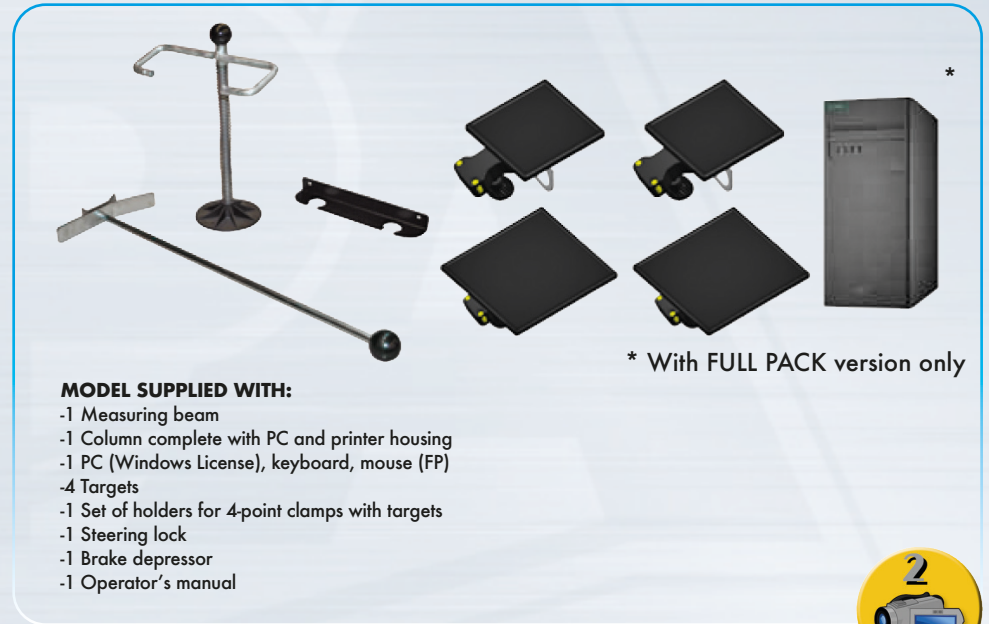

**MODEL SUPPLIED WITH:**

- 1 Measuring beam
- 1 Column complete with PC and printer housing
- 1 PC (Windows License), keyboard, mouse (FP)
- 4 Targets
- 1 Set of holders for 4-point clamps with targets
- 1 Steering lock
- 1 Brake depressor
- 1 Operator's manual

\* With FULL PACK version only

PN	Power Supply	Description
0-34102201/36	115-230V/1PH/50-60Hz	<b>C880 iNext Full Pack</b> - Two 5-Megapixel digital camera for machine vision, NEW LIGHT TARGETS WITH ANTI-REFLECTIVE FILTER, SUITABLE FOR ANY WHEEL CLAMP. Provided with measuring beam, column, PC, keyboard, mouse, 4 hi-resolution light targets, steering wheel lock, brake depressor. LCD Display, printer, wheel clamps and turntables not included.
0-34102301/36	115-230V/1PH/50-60Hz	<b>C880 iNext NO-PC</b> - Features: Two 5-Megapixel digital camera for machine vision, NEW LIGHT TARGETS WITH ANTI-REFLECTIVE FILTER, SUITABLE FOR ANY WHEEL CLAMP. Provided with measuring beam, column, 4 hi-resolution light targets, steering wheel lock, brake depressor. LCD Display, wheel clamps, PC, printer, keyboard, mouse and turntables not included.
8-34900067/25		<b>Customization kit:</b> alignment software, user manuals, customization items (compulsory)



: New or Modified Item

# CAMERA WHEEL ALIGNERS



## C 880



DELIVERY AVAILABLE  
FROM CHINA ONLY

**C 880**

### MODEL SUPPLIED WITH:

- 1 Measuring beam
- 1 Column complete with PC and printer housing
- 1 PC (Windows License), keyboard, mouse (FP)
- 4 Targets and 4 Clamps 10"-21"
- 4 Adaptor kit up to 26"
- 1 Pair of turntables with ROC adaptors
- 1 Set of holders for 4-point clamps with targets
- 1 Steering lock
- 1 Brake depressor
- 1 Operator's manual



C880 Kit configuration



PN	Power Supply	Description
0-34900311/25	115-230V/1Ph/50-60Hz	<b>C 880 FP</b> (Full Pack). <i>DELIVERY AVAILABLE FROM CHINA ONLY</i>
0-34900304/25	115-230V/1Ph/50-60Hz	<b>C 880</b> (NO PC). <i>DELIVERY AVAILABLE FROM CHINA ONLY</i>
0-34900306/00		<b>C 880 Kit</b> . <i>DELIVERY AVAILABLE FROM CHINA ONLY</i>



  : New or Modified Item



# CAMERA WHEEL ALIGNERS



## C 880 W

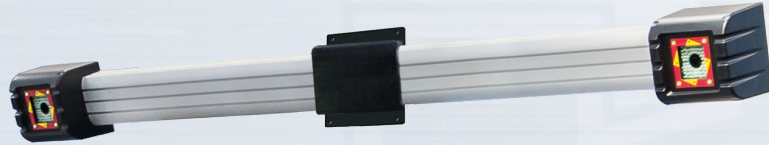

Monitor and Cover cables  
NOT included



DELIVERY AVAILABLE  
FROM CHINA ONLY

### C 880 W

#### MODEL SUPPLIED WITH:

- 1 Measuring beam with special wall bracket
- 1 Wall mounting console with PC and printer housing
- 1 PC (Windows License), keyboard, mouse (FP)
- 4 Targets and 4 Clamps 10"-21"
- 4 Adaptor kit up to 26"
- 1 Pair of turntables with ROC adaptors
- 1 Steering lock
- 1 Brake depressor
- 1 Operator's manual

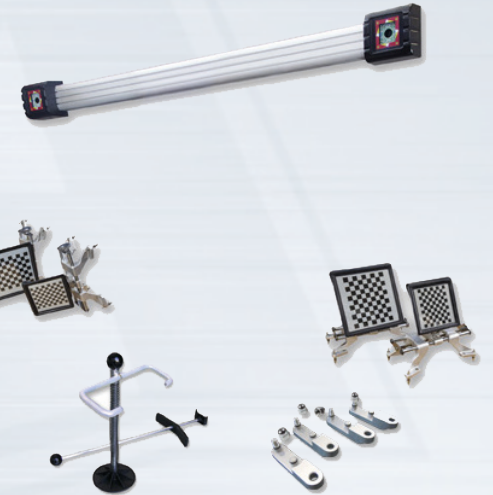

C880 W Kit configuration



PN	Power Supply	Description
0-34900319/25	115-230V/1Ph/50-60Hz	<b>C 880 W FP</b> (Wall installation) (Full Pack). <i>DELIVERY AVAILABLE FROM CHINA ONLY</i>
0-34900310/25	115-230V/1Ph/50-60Hz	<b>C 880 W</b> (Wall installation) (NO PC). <i>DELIVERY AVAILABLE FROM CHINA ONLY</i>
0-34900318		<b>C 880 W Kit</b> <i>DELIVERY AVAILABLE FROM CHINA ONLY</i>



: New or Modified Item



# CAMERA WHEEL ALIGNERS



## C880 iNEXT DRIVE

Monitor  
NOT included



two camera professional wheel aligner for cars and vans drive thru



**MODEL SUPPLIED WITH:**

- 1 PC (Windows License), keyboard, mouse ; 4 Targets; 1 Steering lock; 1 Brake depressor ; 1 Operator's manual

\* With FULL PACK version only

## C 880 iNEXT DRIVE





PN	Power Supply	Description
0-34102401/25	115-230V/1PH/50-60Hz	<b>C880 iNEXT Drive FULL PACK:</b> Wheel aligner and precheck with two Hi-Q digital camera for machine vision, suitable for any wheel clamp. Provided with camera measuring units, wheeled cabinet, PC, keyboard, mouse, 4 hi-resolution light targets with anti-reflective filter, steering wheel lock, brake depressor. LCD Display, printer, wheel clamps, turntables and side posts not included.
0-34102501/25	115-230V/1PH/50-60Hz	<b>C880 iNEXT Drive NO-PC:</b> Wheel aligner and precheck with two Hi-Q digital camera for machine vision, suitable for any wheel clamp. Provided with camera measuring units, wheeled cabinet, 4 hi-resolution light targets with anti-reflective filter, steering wheel lock, brake depressor. PC, keyboard, mouse, LCD display, printer, wheel clamps, turntables and side posts not included.
8-34900083		<b>Customization kit</b> to be ordered with C880 iNEXT Drive: alignment software, user manuals, customization items (compulsory)





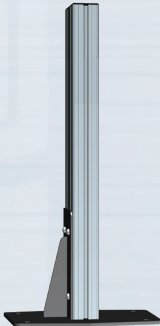



: New or Modified Item

## COMPULSORY ACCESSORIES FOR C 880 INEXT DRIVE



PN	Picture	Description
8-34900080		<b>KIT LOW COLUMNS (1.000mm):</b> for installation in pit or for precheck in acceptance. <b>COMPULSORY</b> (as an alternative to P/N 8-34900081)
8-34900081		<b>KIT HIGH COLUMNS (2600 mm):</b> for installation with hoist. Measurement and adjustment operations at fixed height. <b>COMPULSORY</b> (as an alternative to P/N 8-34900080)

# OPTIONAL ACCESSORIES FOR CAMERA WHEEL ALIGNERS





PN	Picture	Description	C2000 Néos	C 880 iNEXT	C 880	C 880 WALL	C 880 iNEXT DRIVE
8-21120005		<b>USB inkjet printer kit.</b> Available only for shipment from Italy		●	●	●	●
8-34900079		<b>USB inkjet printer kit.</b> Not available for shipment from Italy		●	●	●	●
8-31600017		<b>4-point</b> clamp support brackets for wall installation (4 pcs).	●	●	●	●	●
8-61200237		A4 colour inkjet <b>printer</b> set - USB connection	●				
8-34900095/90		<b>Shelf for printer</b> Alternative mounting to the support for second LCD monitor. Mandatory if the printer is ordered.	●				
8-34900093		Secondary LCD <b>display support</b>	●				





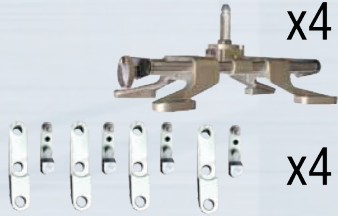

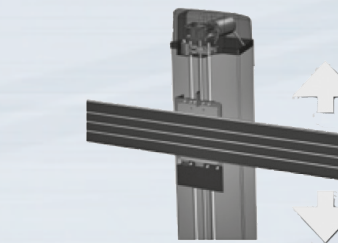
# OPTIONAL ACCESSORIES FOR CAMERA WHEEL ALIGNERS

PN	Picture	Description	C2000 Néos	C 880 iNEXT	C 880	C 880 WALL	C 880 iNEXT DRIVE
8-31600016		32" LCD monitor	●	●			●
8-34120000		Monitor 27" widescreen base.	●	●	●	●	●
8-21100234		Monitor LCD/LED 22" Widescreen.	●	●	●	●	●

# OPTIONAL ACCESSORIES FOR CAMERA WHEEL ALIGNERS

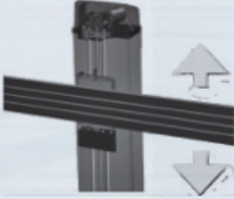
PN	Picture	Description	C2000 Néos	C 880 iNEXT	C 880	C 880 WALL	C 880 iNEXT DRIVE
8-34100022	 x4 x4	<b>4x 4-points</b> 11"-21" wheel clamps for cars, with 26" extenders included		●			●
8-34100020	 x4	<b>4x 4-points</b> 11"-21" wheel clamps for cars		●			●
8-34100021	 x4	<b>Kit of extenders</b> to 26" for clamps code 8-34100020		●			●
8-34900064		<b>CM Camera Mover</b> with wormgear 115-230V/1PH/50-60Hz		●			
8-34900071		<b>CM lift autotracking</b> enabling kit for the CM camera mover with wormgear	●	●			
8-33100050		Steering <b>wheel level</b>	●	●	●	●	●

# OPTIONAL ACCESSORIES FOR CAMERA WHEEL ALIGNERS

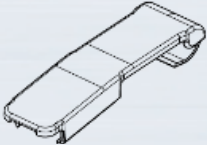



PN	Picture	Description	C2000 Neos	C 880 iNEXT	C 880	C 880 WALL	C 880 iNEXT DRIVE
8-34900059		<b>CM</b> - (Camera Mover) with wormgear 115-230V/1PH/50-60Hz  DELIVERY AVAILABLE FROM CHINA ONLY			●		
8-33100189		<b>ClampOnTyre</b> : Quick, self-centring, ergonomic. Fixing to the wheel, without contact with the rim. The supplied jaws allow gripping on wheel diameters from 19" to 32". Wheel arch protection included. The code includes one clamp. REMARK: To use the ClampOnTyre with C880 iNEXT aligner it is mandatory to order kit 8-34100048	●	●			●
8-33100191		<b>Set of extensions</b> for vans: set for use with vans. Kit for one clamp.	●	●			●
8-33100190		<b>Set of XL extensions</b> : for wheel diameter from 32" to 39". Kit for one clamp.	●	●			●
8-33100196		<b>Fall protection steel cable kit for 4 clamps</b> : includes 4 steel cables and mounting components. Compatible with ClampOnTyre.	●	●			●
8-33100197		<b>Wheel Rim Guard Kit</b> : Plastic protection for very protruding rims. Compatible with ClampOnTyre.	●	●			●









# OPTIONAL ACCESSORIES FOR CAMERA WHEEL ALIGNERS

PN	Picture	Description	C2000 Néos	C 880 iNEXT	C 880	C 880 WALL	C 880 iNEXT DRIVE
8-33100193		<b>Clamp holder multi-purpose trolley</b> and additional jaws.	●	●			●
8-33100192		<b>Clamp holder set</b> for wall mounting with support for additional jaws.	●	●			●
8-33100195	 x4	<b>Set of 4</b> spacers for installation of kit 8-33100192 where ClampOnTyres are fitted with VAN extensions 8-33100191		●			
8-34900072/90		<b>Aligner Trolley II:</b> to use the wheel aligner in different working bays or in drive-thru mode	●	●	●		
8-34100032		<b>Drive-On assistant:</b> driving assistance camera for easy and correct positioning of the vehicle on the lift or in the workshop without the help of an assistant or mirrors.	●				

# OPTIONAL ACCESSORIES FOR CAMERA WHEEL ALIGNERS







PN	Picture	Description	C2000 Néos	C 880 iNEXT	C 880	C 880 WALL	C 880 iNEXT DRIVE
8-34900074/25		<b>Trolley 2.0:</b> trolley for wheel clamps and targets		●			●
8-34900018/25		Smart <b>trolley</b> for clamp & target holders (1 unit).			●	●	
8-34900036/25		<b>Wheeled cabinet.</b>		●	●	●	●
8-34900011		<b>Complete Calibrator 2.0</b> for calibration and maintenance. Bar calibration procedure. NOTE: Only suitable for "A" version aligners.	●	●	●	●	●
8-34900028		<b>Single target "B"</b> for calibration only. NOTE: Only suitable for "B" version aligners.			●	●	

# OPTIONAL ACCESSORIES FOR CAMERA WHEEL ALIGNERS



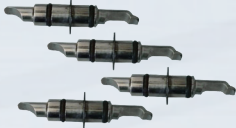

PN	Picture	Description	C2000 Néos	C 880 iNEXT	C 880	C 880 WALL	C 880 iNEXT DRIVE
8-34900021		<b>Drive-On assistant</b> One Camera system for easy vehicle positioning in the working bay.		●	●	●	
8-35100060		<b>Universal radio remote control</b> set. 2.4 GHz industrial radio frequency.	●	●	●	●	●
8-31100001		<b>NEXREMOTE</b> Based on a SAMSUNG tablet, can be used as a remote control and an additional screen. Comprising: -1 SAMSUNG Tablet + 1 Rubber protection cover. -1 Wi-Fi Router.	●	●	●	●	●
8-33200056		<b>10 credits card</b> for wheel alignment ON LINE data bank.		●	●	●	●
8-34100048	<b>SMART ROC</b>	<b>SMART-ROC feature enable</b> MANDATORY FOR THE USE OF CLAMPONTYRE QUICK CLAMPS		●			●
8-34900023		<b>Data Base update</b>		●	●	●	●
8-34900029		US cars <b>data bank activation</b> (to renew yearly)		●	●	●	●
8-34900053		<b>Animations full update kit</b>		●	●	●	●
8-34900098		<b>Animations full update kit</b>	●				
8-34900097		Vehicle adjustment by <b>schematic slides</b>	●	●			●





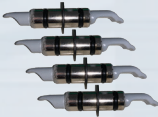



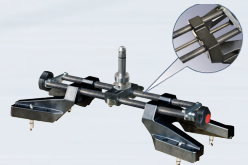

# OPTIONAL ACCESSORIES FOR CAMERA WHEEL ALIGNERS

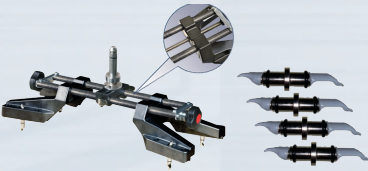
PN	Picture	Description	C2000 Néos	C 880 iNEXT	C 880	C 880 WALL	C 880 iNEXT DRIVE
8-34100027	IMAGE NOT AVAILABLE	<b>AVP kit</b> (Audi e VW Procedure)		●	●	●	●
8-33200058		<b>CAL ONE TOUCH 2.0</b> - Subscription for data bank yearly Update		●	●	●	●
8-34900031		<b>US cars data bank</b> activation kit	●				
8-34900019		<b>Pair of mechanical turntables</b> with ROC push-mode (without wheel stop) Dimensions: 485x435x48,5 mm Load: 1000 Kg		●	●	●	●
8-34100052	 X2	<b>ROC push-mode kit</b> - for turntables 8-34900019		●	●	●	●
8-34900041		<b>Set of four STD double-profile claws.</b>		●	●	●	●
8-33100039		<b>Set of four double-profile claws</b> - Suitable for PN. 8-33200060	●	●			●

# OPTIONAL ACCESSORIES FOR CAMERA WHEEL ALIGNERS









PN	Picture	Description	C2000 Néos	C 880 iNEXT	C 880	C 880 WALL	C 880 iNEXT DRIVE
8-33120000		<b>Set of 4 SCC pins</b> , suitable for: 8-33200038, 8-33200060, 8-33200063 and 8-33200064	●	●			●
8-33120001		<b>kit of 4 resin coated double-profile claws</b> for wheel clamps. One kit for one clamp.		●	●	●	●
8-33120002		<b>Kit of 4 resin coated/double-profile claws</b> for wheel clamps code 8-33200060, 8-33200064 and 8-33200063. One kit for one clamp.	●	●			●
8-33120003		<b>Kit of 4 resin coated/double-profile SCC claws</b> for wheel clamps code 8-33200060, 8-33200064 and 8-33200063. One kit for one clamp.	●	●			●
8-33200060		<b>Pair of 4-point clamps</b> from 10" to 21"	●	●			●
8-34100029		<b>Pair of 4-point clamps</b> from 10" to 21" with resin coated/double-profile claws	●	●			●
8-33200063		<b>Extra light 4-point clamp</b> from 10" to 26" with carbon inserts	●	●			●

# OPTIONAL ACCESSORIES FOR CAMERA WHEEL ALIGNERS



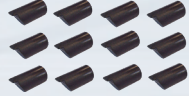

PN	Picture	Description	C2000 Neos	C 880 iNEXT	C 880	C 880 WALL	C 880 iNEXT DRIVE
8-33200066		<b>Extra light 4-point</b> clamp from 10" to 26" with carbon inserts and resin coated/double-profile claws	●	●			●
8-33100184		<b>Wheel hook kit</b> for 4-points clamps (kit for 4 clamps)	●	●			●
8-33100185		<b>Kit of 4</b> plastic pins type 1 for P/N 8-33100184	●	●			●
8-33100186		<b>Kit of 4</b> plastic pins type 2 for P/N 8-33100184	●	●			●
8-33100187		<b>Kit of 4</b> plastic pins type 3 for P/N 8-33100184	●	●			●
8-33100100		<b>Extension set to 30"</b> .	●	●			●
8-33200027		<b>Pair of 3-point</b> manual quick clamps from 9" to 21". Supplied with short and outstanding profile rim claws.	●	●			●
8-33100026		<b>Extension set to 28"</b> - Suitable for PN. 8-33200027	●	●			●



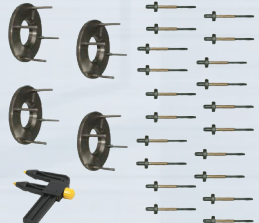

# OPTIONAL ACCESSORIES FOR CAMERA WHEEL ALIGNERS

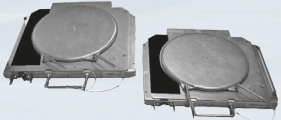
PN	Picture	Description	C2000 Néos	C 880 iNEXT	C 880	C 880 WALL	C 880 iNEXT DRIVE
803269218		Set of four 3-point automatic quick clamps from 10" to 20"	●	●			●
803289414		Set of 12 claws for Iveco Daily steel rims	●	●			●
8-33200003		Set of 12 extensions to 22" for 3-point quick clamps	●	●			●
803284944		Set of 12 short claws - Suitable for PN. 8-33200027 or 803269218	●	●			●
803284945		Set of 12 long claws (57 mm) - Suitable for PN. 8-33200027 or 803269218	●	●			●
803284946		Set of 12 shaped claws - Suitable for PN. 8-33200027 or 803269218	●	●			●
8-33200004		Set of 12 claws for outstanding profile rims	●	●			●
803284947		Set of 12 extensions - Suitable for PN. 8-33200027 or 803269218	●	●			●

# OPTIONAL ACCESSORIES FOR CAMERA WHEEL ALIGNERS

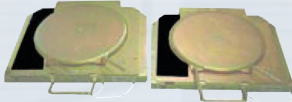
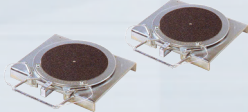

PN	Picture	Description	C2000 Nèos	C 880 iNEXT	C 880	C 880 WALL	C 880 iNEXT DRIVE
803284942		<b>Complete set</b> of Mercedes and BMW adapters (25 pcs)	●	●			●
803284943		<b>Complete set</b> of Porsche adapters (4+4 pcs.)	●	●			●
8-33200039		<b>Pair of wheel clamps self-centering</b> and self ROC for Mercedes and BMW	●	●			●
8-33100102		<b>Pair of car mechanical turntables</b> with ROC push-mode kit (Without wheel stop). Dimensions: 400x450x50 mm - Ø 320 mm - Range: ± 40 mm. Load: 1000 kg.	●	●			●
8-33100103		<b>Pair of wheel stops</b> for turntables PN. 8-33100102	●	●			●
804241069		<b>Car mechanical turntable</b> - H=53 mm	●	●			●

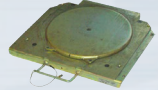
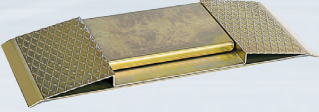
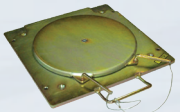
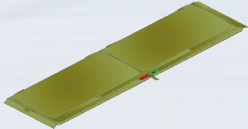
# OPTIONAL ACCESSORIES FOR CAMERA WHEEL ALIGNERS

PN	Picture	Description	C2000 Néos	C 880 iNEXT	C 880	C 880 WALL	C 880 iNEXT DRIVE
803259570		<b>ROC push-mode kit</b> (2 pcs.) for turntables PN. 803241069, 803227745, 8-33100102. MANDATORY FOR PRODUCTS USING THE "ROC SMART" FUNCTION.	●	●	●	●	●
803268866		<b>Pair of car mechanical turntables</b> - H=50 mm	●	●			●
8-33100111		<b>ROC push-mode kit</b> (2 pcs.) for turntables PN. 803268866	●	●			●
803227745		<b>High profile car turntable</b> H=35 mm	●	●			●
803227757		<b>Short car slip plate</b> to matching with turntable PN. 803227745	●	●			●
803229274		<b>Low profile car turntable</b> H=26 mm	●	●			●
803231255		<b>Long car slip plate</b>	●	●			●



# OPTIONAL ACCESSORIES FOR CAMERA WHEEL ALIGNERS

PN	Picture	Description	C2000 NeoS	C 880 iNEXT	C 880	C 880 WALL	C 880 iNEXT DRIVE
803254284		<b>AMV 1925 device</b> for cars with V.A.S. group MULTILINK suspensions	●	●			●
8-33100049		<b>Toe pressure bar</b> for Mercedes vehicles	●	●			●
8-35100059		Portable <b>induction heater</b> .	●	●	●	●	●

# RADIO/CCD WHEEL ALIGNERS



## C 500 1.1



### MODEL SUPPLIED WITH:

- 1 Main unit on wheels
- 1 Set of 4 Radio measuring heads
- 1 PC with keyboard and optical mouse
- 1 Set of 4 emergency cables.
- 1 CD ROM with back-up program and passenger vehicles Data Bank.
- 1 Kit with AAP and AVP procedures
- 1 Radio module for control unit and Hardlock.
- 2 Battery set (4 + 4 pcs.) + 1 Battery recharger,
- 1 Steering wheel holder and 1 Pedal depressor
- 1 Operator's manual

## C 500 1.1



PN	Power Supply	Description
0-33217103/25	115-230V/1Ph/50-60Hz	C 500 1.1



: New or Modified Item

# RADIO/CCD WHEEL ALIGNERS



## C 500 1.1 ROAD TRUCK

Portable professional wheel alignment with 8 sensors for light and heavy transport.



### MODEL SUPPLIED WITH:

- 1 Carrying case
- 1 Set of 4 Radio measuring heads derived from C500 1.1
- 1 Battery set (4 pcs.) + 1 Battery recharger
- 1 Radio module for control unit and Hardlock
- 1 DVD with truck and car software.
- 1 Operator's manual.

## C 500 1.1 ROAD TRUCK





PN	Power Supply	Description
0-33225001	115-230V/1Ph/50-60Hz	<b>C 500 1.1 Road Truck</b>



 : New or Modified Item



## OPTIONAL ACCESSORIES FOR C 500 1.1 ROAD TRUCK

PN	Picture	Description	
8-33100161		<b>LAPTOP PC</b> with WINDOWS10.	
8-33100170		<b>RUGGED laptop PC</b> with Windows 10	

# RADIO/CCD WHEEL ALIGNERS



## C 400 iNEXT



### MODEL SUPPLIED WITH:

- 1 Main unit on wheels
- 1 Set of 4 Radio measuring heads
- 1 Set of 4 emergency cables.
- 1 PC with keyboard
- 1 CD ROM with back-up program and passenger vehicles Data Bank.
- 1 Radio module for control unit and Hardlock
- 1 Steering wheel holder
- 1 Pedal depressor
- 1 Operator's manual

### C 400 iNEXT



PN	Power Supply	Description
0-33220201/25	115-230V/1Ph/50-60Hz	<b>C 400 iNEXT</b>



: New or Modified Item

# RADIO/CCD WHEEL ALIGNERS



## C 200 iNEXT



### MODEL SUPPLIED WITH:

- 1 Main unit on wheels
- 1 Set of 4 Radio measuring heads with batteries and charging system.
- 1 PC with keyboard
- 1 Radio module for control unit and Hardlock.
- 1 DVD with back-up program and passenger vehicles Data Bank.
- 1 Steering wheel holder
- 1 Pedal depressor
- 1 Operator's manual

### C 200 iNEXT



PN	Power Supply	Description
0-33223001/25	115-230V/1Ph/50-60Hz	<b>C 200 iNEXT</b>



: New or Modified Item



# RADIO/CCD WHEEL ALIGNERS



## C 200 ROAD



### MODEL SUPPLIED WITH:

- 1 Case for measuring heads
- 1 Set of 4 Radio measuring heads with batteries and charging system.
- 1 "Road electric panel
- 1 Radio module for control unit and Hardlock.
- 1 CD with back-up program + SIM card.
- 1 Operator's manual

### C 200 ROAD

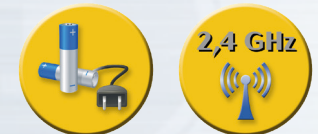

PN	Power Supply	Description
0-39201501	115-230V/1Ph/50-60Hz	<b>C 200 Road</b>



: New or Modified Item

# RADIO/CCD WHEEL ALIGNERS



## C 200 iNEXT SMART

Self-centering staples NOT included



### MODEL SUPPLIED WITH

- 1 Main unit
- 1 "Road electric panel
- 1 Radio module for control unit and Hardlock.
- 1 CD with back-up program + SIM card.
- 1 Steering wheel holder
- 1 Pedal depressor
- 1 Operator's manual

### C 200 iNEXT SMART



PN	Power Supply	Description
0-3311150101/39	100/240Vac - 1Ph - 50/60Hz	<b>C200 iNext SMART Wheel aligner</b> including 4 wireless sensors and "docking station " (equipped with charging stands, battery charger and brackets holder), steering wheel lock and depressor. Floor or wall fixing.
8-33100180		<b>Compulsory customized kit</b> for C200 Inext SMART including alignment software, user manuals, customizing items



: New or Modified Item

# OPTIONAL ACCESSORIES FOR C 200 ROAD AND C 200 INEXT SMART

PN	Picture	Description	C 200 Road	C 200 iNext smart
8-33100161		<b>Laptop PC</b> with Windows 10	●	●
8-33100170		<b>RUGGED laptop PC</b> with Windows 10	●	●
8-34100022	 x4 x4	<b>4x 4-points 11"-21"</b> wheel clamps for cars, with 26" extenders included		●
8-34100020	 x4	<b>4x 4-points 11"-21"</b> wheel clamps for cars		●
8-34100021	 x4	<b>Kit of extenders</b> to 26" for clamps code 8-34100020		●



## OPTIONAL ACCESSORIES FOR C 200 ROAD AND C 200 INEXT SMART

PN	Picture	Description	C 200 Road	C 200 iNext smart
8-34900036/25		Wheeled cabinet	●	●

## OPTIONAL ACCESSORIES FOR "C" SERIES





PN	Picture	Description	C 1000 iNEXT	C 500 1.1	C 400 iNEXT	C 200 series
8-31100001		<b>NEXREMOTE</b> Based on a SAMSUNG tablet, can be used as a remote control and an additional screen. Comprising: -1 SAMSUNG Tablet + 1 Rubber protection cover. -1 Wi-Fi Router.	●	●	●	●
8-33100174		<b>Wi-Fi connection kit</b> for INDUSTRY 4.0	●	●	●	●
8-34120000		27" <b>Basic Widescreen Monitor.</b>	●			
8-21100234		22" <b>Widescreen LCD/LED monitor.</b>		●	●	●
8-61200143		LCD <b>monitor support.</b>		●	●	●

## OPTIONAL ACCESSORIES FOR "C" SERIES



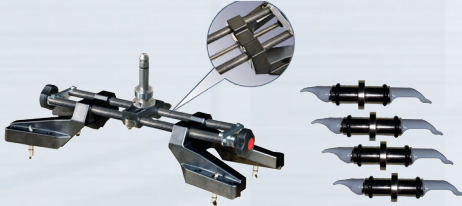

PN	Picture	Description	C 1000 iNEXT	C 500 1.1	C 400 iNEXT	C 200 series
8-61200237		A4 colour inkjet <b>printer</b> set - USB connection.	●	●	●	●
8-33200020		<b>Procedure kits:</b>	●	■	●	●
8-33200021		AVP Kit (Audi, VW Procedure).	■	■	●	●
8-33200022		AAP Kit (Animated Adjustment Procedure).		●	●	
8-33200024		TTP Kit (Truck & Trailer procedure). Kit MBP (Mercedes Benz Procedure).	●	●	●	
8-33200056		<b>10 credits card</b> for wheel alignment ON LINE data bank. Also suitable for all "C" series aligners no longer in production. Internet Download link: <a href="http://www.simpesfaip.it/infoauto">www.simpesfaip.it/infoauto</a>	●	●	●	●
8-33200031		<b>Software update</b> (without new Data Bank).		●	●	●
8-33100125		<b>US cars data bank</b> activation kit.	●	●	●	●
8-33200063		<b>Extra light 4-point</b> clamp from 10" to 26" with carbon inserts, built-in spoiler adapter and double-profile claws. NOTE: suitable for passenger car and truck (with extension set PN. 8-33100100).	●	●	●	●

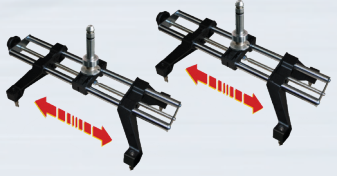

## OPTIONAL ACCESSORIES FOR "C" SERIES

PN	Picture	Description	C 1000 iNEXT	C 500 1.1	C 400 iNEXT	C 200 series
8-33200066		<b>Extra light 4-point</b> clamp from 10" to 26" with carbon inserts and resin coated/double-profile claws	●	●	●	●
8-33100100		<b>Extension set</b> to 30".	●	●	●	●
8-33100157		<b>SPIDER CLAMP</b> Set of 4 claws ideal solution not to touch the rim. Application in a few seconds. ROC procedure required. Suitable for PN. 8-33200063. NOTE: set for one clamp only.	●			
8-33100146		<b>Quick wheel clamp</b> 13" to 28" (for new rims or rims in good conditions); compensation kit; spacers for rounded rims included; spirit level included		●	●	●
8-33200064		<b>Pair of 4-point</b> clamps from 10" to 21" with sliding pin.	●	●	●	●

## OPTIONAL ACCESSORIES FOR "C" SERIES

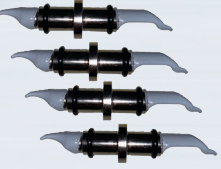
PN	Picture	Description	C 1000 iNEXT	C 500 1.1	C 400 iNEXT	C 200 series
8-34100028		Pair of 4-point clamps from 10" to 21" with sliding pins and resin coated/double-profile claws	●	●	●	●
8-33200060		Pair of 4-point clamps from 10" to 21".	●	●	●	●
8-34100029		Pair of 4-point clamps from 10" to 21" with resin coated/double-profile claws	●	●	●	●
8-33120002		Kit of 4 resin coated/double-profile claws for wheel clamps code 8-33200060 and 8-33200063. One kit for one clamp.	●	●	●	●
8-33120003		Kit of 4 resin coated/double-profile SCC claws for wheel clamps code 8-33200060 and 8-33200063. One kit for one clamp.	●	●	●	●

## OPTIONAL ACCESSORIES FOR "C" SERIES

PN	Picture	Description	C 1000 iNEXT	C 500 1.1	C 400 iNEXT	C 200 series
8-33100039		<b>Set of 4 double-profile claws.</b> Suitable for: 803287985 (→ 2006) 8-33200060 and 8-33200064.	●	●	●	●
8-33120000		<b>Set of 4 SCC pins.</b> Suitable for: 8-33200038, 8-33200060 and 8-33200064	●	●	●	●
8-34900045		<b>Set of 4 elastic cords suitable for all clamp types.</b>	●	●	●	●
803289779		<b>Pair of heavy-duty 4-point clamps from 17,5" to 25".</b>		●	●	
803258555		<b>Set of 4 RACING claws - Suitable for PN. 803289779.</b> NOTE: set for one clamp only.		●	●	







## OPTIONAL ACCESSORIES FOR "C" SERIES

PN	Picture	Description	C 1000 iNEXT	C-500 1.1	C 400 iNEXT	C 200 series
8-33200027		<b>Pair of 3-point</b> manual quick clamps from 9" to 21". Supplied with short and outstanding profile rim claws.	●	●	●	●
8-33100026		<b>Extension set</b> to 28" - Suitable for PN. 8-33200027. NOTE: set for one clamp only.	●	●	●	●
803269218		<b>Set of 4 3-point</b> automatic quick clamps from 10" to 20". For ALU rims and well centered rims, "run out" compensation is not required.	●	●	●	●
803289414		<b>Set of 12 claws</b> for Iveco Daily steel rims. (Only used in combination with 3-point clamps PN. 8-33200027 or 803269218).	●	●	●	●

# OPTIONAL ACCESSORIES FOR "C" SERIES

PN	Picture	Description	C 1000 iNEXT	C 500 1.1	C 400 iNEXT	C 200 series
8-33200003		<b>Set of 12</b> extensions to 22" for 3-point quick clamps. (Suitable for PN. 803269218).	●	●	●	●
803284944		<b>Set of 12</b> short claws. Suitable for PN. 8-33200027 or 803269218.	●	●	●	●
803284945		<b>Set of 12</b> long claws (57 mm). Suitable for PN. 8-33200027 or 803269218.	●	●	●	●
803284946		<b>Set of 12</b> shaped claws. Suitable for PN. 8-33200027 or 803269218.	●	●	●	●
8-33200004		<b>Set of 12</b> claws for outstanding profile rims. Suitable for PN. 8-33200027 or 803269218.	●	●	●	●
803284947		<b>Set of 12</b> extensions. Suitable for PN. 8-33200027 or 803269218.	●	●	●	●

## OPTIONAL ACCESSORIES FOR "C" SERIES

PN	Picture	Description	C 1000 iNEXT	C 500 1.1	C 400 iNEXT	C 200 series
803284942		<b>Complete set</b> of Mercedes and BMW adapters (25 pcs). (Only used in combination with 3-point clamps PN. 8-33200027 or 803269218).	●	●	●	●
803284943		<b>Complete set</b> of Porsche adapters (4+4 pcs.). (Only used in combination with 3-point clamps PN. 8-33200027 or 803269218).	●	●	●	●
8-33200039		<b>Pair of wheel clamps self-centering</b> and self ROC for Mercedes and BMW.	●	●	●	●
8-33100051		<b>Set of 4 self-centering wheel clamps - ROC skip</b> for trucks "on the road". For ALU rims and well centered rims, "run out" compensation is not required.		●	●	



## OPTIONAL ACCESSORIES FOR "C" SERIES

PN	Picture	Description	C 1000 iNEXT	C 500 1.1	C 400 iNEXT	C 200 series
8-33100104		<b>Set of 6 short spacers</b> for PN. 8-33100051. To mounting the two <u>rear</u> clamps on axles <u>without</u> dual wheels.		●	●	
8-33100105		<b>Set of 6 long spacers</b> for PN. 8-33100051. To mounting the two <u>rear</u> clamps on axles <u>without</u> dual wheels.		●	●	
803261967		<b>Pair of car professional</b> electronic turntables Dimensions: 450x450x50 mm. Ø 345 mm - Range: ± 50 mm. Low friction < 5 Nm. Load: 1000 kg.		●		
8-33100017		<b>ROC push-mode kit</b> (2 pcs.) for turntables PN. 803261967.		●		
8-33100030		<b>Set of 4 drive-on ramps</b> for turntables PN. 803261967.		●		

## OPTIONAL ACCESSORIES FOR "C" SERIES

PN	Picture	Description	C 1000 iNEXT	C 500 1.1	C 400 iNEXT	C 200 series
8-33100102		<b>Pair of car mechanical turntables</b> with ROC push-mode kit (Without wheel stop). Dimensions: 400x450x50 mm - Ø 320 mm - Range: ± 40 mm. Load: 1000 kg.	●	●	●	●
8-33100103		<b>Pair of wheel stops</b> for turntables PN. 8-33100102.	●	●	●	●
804241069		<b>Car mechanical turntable.</b> Dimensions: 400x450x53 mm. Ø 320 mm - Range: ± 40 mm. Load: 1000 kg.	●	●	●	●
803259570		<b>ROC push-mode kit</b> (2 pcs.) for turntables PN. 803241069, 803227745, 8-33100102. MANDATORY FOR PRODUCTS USING THE "ROC SMART" FUNCTION.	●	●	●	●
803268866		<b>Pair of car mechanical turntables</b> with graduated scale. Dimensions: 375x305x50 mm. Ø 310 mm - Range: ± 35 mm. Load: 1000 kg.	●	●	●	●

## OPTIONAL ACCESSORIES FOR "C" SERIES

PN	Picture	Description	C 1000 iNEXT	C 500 1.1	C 400 iNEXT	C 200 series
8-3310011		<b>ROC push-mode kit</b> (2 pcs.) for turntables PN. 803268866.	●	●	●	●
803227745		<b>High profile car turntable</b> Dimensions: 400x450x36 mm. Ø 320 mm - Range: ± 40 mm. Load: 1000 kg.	●	●	●	●
803227757		<b>Short car slip plate</b> to matching with turntable PN. 803227745. Dimensions: 835x370x37 mm. Load: 1000 kg.	●	●	●	●
803229274		<b>Low profile car turntable</b> Dimensions: 400x450x26 mm. Ø 320 mm - Range: ± 40 mm. - Load: 1000 kg.	●	●	●	●
803231255		<b>Long car slip plate</b> Dimensions: 1732x535x25 mm. Load: 1000 kg.	●	●	●	●



## OPTIONAL ACCESSORIES FOR "C" SERIES

PN	Picture	Description	C 1000 iNEXT	C 500 1.1	C 400 iNEXT	C 200 series
803230950		<b>Heavy-duty turntable for trucks.</b> Dimensions: 450x450x24 mm. Ø 365 mm - Range: ± 45 mm. Load: 3000 kg		●	●	
8-33100099		<b>Pair of truck mechanical turntables with graduated scale.</b> Dimensions: 370x458x66 mm. Ø 370 mm - Range: ± 50 mm. Load: 5000 kg.		●	●	
8-33200010		<b>Pair of spoiler adapters for cars.</b>		●	●	●
803289583		<b>Pair of spoiler adapters for trucks.</b>		●	●	
8-33200029		<b>Trailer alignment kit.</b>		●	●	

## OPTIONAL ACCESSORIES FOR "C" SERIES



PN	Picture	Description	C 1000 iNEXT	C 500 1.1	C 400 iNEXT	C 200 series
803254284		<b>AMV 1925 device</b> for cars with V.A.S. group MULTILINK suspensions.	●	●	●	●
8-33200150		<b>Calibration unit provided</b> with the full scale inclinometers calibration kit. Do not include accessories for the full scale calibration of the string aligners.		●	●	●
8-33100199		<b>Full scale calibration kit</b> for string aligners (to be used with 8-33200150).				
8-33200012		<b>Connection cable</b> from main unit to CCD heads L=16 mt.		●	●	
8-35100076		<b>Pair of connection cables</b> for electronic turntables L=16 mt.	●			
8-33100110		<b>Set of 4 emergency cables.</b>				●

## OPTIONAL ACCESSORIES FOR "C" SERIES

PN	Picture	Description	C 1000 iNEXT	C 500 1.1	C 400 iNEXT	C 200 series
8-33100049		Toe pressure bar for Mercedes vehicles.	●	●	●	●
8-33100078		Optical mouse kit.	■	■	●	●
8-33100088		External device kit to recharge the batteries.			●	●
8-33100081		Pedal depressor.	■	■	■	■
8-33100082		Steering wheel holder.	■	■	■	■



## OPTIONAL ACCESSORIES FOR "C" SERIES

PN	Picture	Description	C 1000 iNEXT	C 500 1.1	C 400 iNEXT	C 200 series
8-35100060		<b>Universal radio remote control</b> set. 2.4 GHz industrial radio frequency.  <u>RADIO SYSTEM: USE IN ACCORDING TO THE LOCAL RULES.</u>	●	●	●	●
8-33200058		<b>CAL ONE TOUCH 2.0</b> - Subscription for data bank yearly Update	●	●	●	●
8-34200005		<b>Drive on assistant</b> kit for C1000 iNext.	●			
8-35100059		Portable <b>induction heater</b> .	●	●	●	●

## OPTIONAL ACCESSORIES FOR "C" SERIES

PN	Picture	Description	C 1000 iNEXT	C 500 1.1	C 400 iNEXT	C 200 iNEXT
8-34100005		<b>Service frame for calibration</b> with ISO 9000 certificate. For Technical support Centres only.	●			
8-34100010		<b>Complete calibrator frame</b> For Technical support Centres only. Comprising: 1 Reference bar, 1 Glass target, 1 Support for target central position.	●			
8-34100009		<b>Upgrade conversion kit</b> for PN. 8-34100005 calibration frame. For Technical support Centres only.	●			
8-21100197		<b>Complete tool kit</b> For Technical support Centres only. The kit contains all the mechanics tools necessary to assist both wheel balancers currently in the catalogue and phased.	●	●	●	●
8-33100050		<b>Steering wheel level</b>	●	●	●	●

## UPGRADE TO ALIGNER DATA BANK



Model	PN	Support type
<b>C2000 Néos</b>	8-34100050	USB Stick + USB enable key - 4
<b>C 700 - C 500 - C 400</b>	8-33200030	CD-ROM + Smart card - 1
<b>C 200 - C 500 1.1 - C 400 1.1</b>	8-33200030	CD-ROM + Smart card - 1
<b>C 900 - C 1000</b>	8-33200050	CD-ROM + Smart card - 1
<b>US cars data bank activation kit *</b>	8-33100125	Smart card - 2
<b>C 700 - C 500 - C 400</b>	8-33200031	CD Software

\* - Valid for C 1000 - C 900 - C 700 - C 500 - C 400 and C 200 only. This kit is needed also for the future yearly upgrade. In case you purchase a data bank upgrade without ordering PN 8-33100125, the list of all vehicles will be updated except the one of the cars manufactured in the US. This will remain at the state of the last upgrade (with PN 8-33100125).

**WARNING:** If the activation kit has never been installed before, in case you purchase a data bank upgrade the list of non-American vehicles will be updated, while the list of cars manufactured in the US will be no longer visible.



## DIAGRAM OF PACKING SPECIFICATION

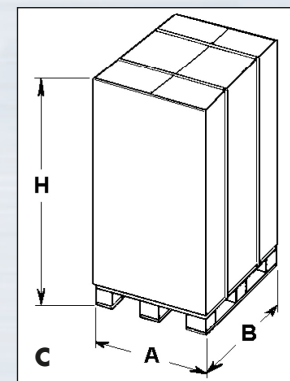
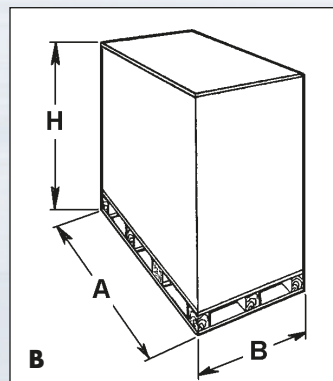
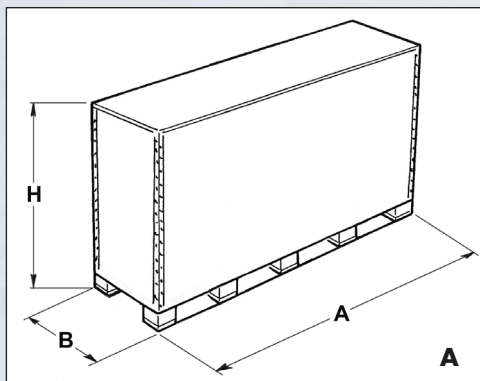

Model	Packing type	Dimensions (cm.) (AxBxH)	Net weight (kg)	Gross weight (kg)
<b>C 1000 iNEXT</b>				
Complete measuring unit	Wooden case (A)	277 x 88 x 66	145	190
<b>C 880</b>				
Complete control unit	Wooden case (A)	298 x 25 x 42	15	40
Column	"	174 x 59 x 31	75	92
Other components	Wooden case (B)	107 x 107 x 78	95	120
Calibration set on trolley	"	102 x 67 x 27	15	27
Radio/CCD wheel aligners				
C 500 1.1 (Main control unit)	Carton box on pallet (C)	74 x 61 x 134	65	90
C 400 iNEXT (Main control unit)	"	74 x 61 x 134	65	90
C 200 iNEXT (Complete)	"	116 x 76x140	65	90
Radio/CCD wheel aligners - Accessories				
Completion accessories (Heads included)	Wooden case (A)	154 x 92 x 113	50	90
C 500 1.1 Measuring heads	Carton box	102 x 81 x 45	19	24



# in the world

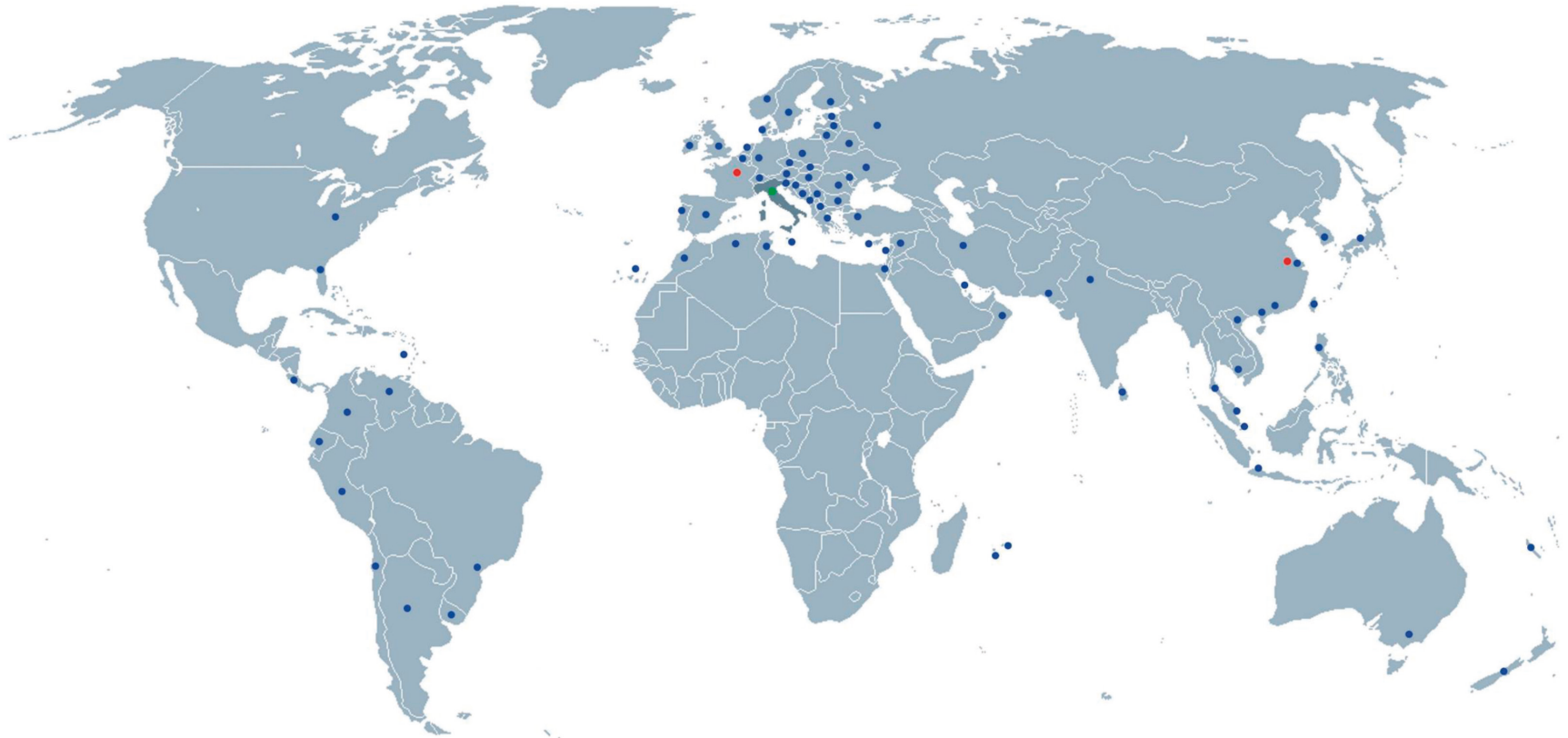

- : HPA-FAIP branch offices in the world.
- : HPA-FAIP distributors.
- : HPA-FAIP head office.

### Sales and after-sales network:

- |             |                  |                 |             |                     |                     |                      |             |
|-------------|------------------|-----------------|-------------|---------------------|---------------------|----------------------|-------------|
| ● ALGERIA   | ● CAMBODIA       | ● ECUADOR       | ● INDIA     | ● MACAO             | ● NEW ZEALAND       | ● RUSSIAN FEDERATION | ● TAIWAN    |
| ● ARGENTINA | ● CANARY ISLANDS | ● ESTONIA       | ● INDONESIA | ● MACEDONIA         | ● NORWAY            | ● SERBIA             | ● THAILAND  |
| ● AUSTRALIA | ● CHILE          | ● FINLAND       | ● IRAN      | ● MALAYSIA          | ● OMAN              | ● SINGAPORE          | ● THAILAND  |
| ● AUSTRIA   | ● CHINA (RP)     | ● FRANCE        | ● IRELAND   | ● MALTA             | ● PAKISTAN          | ● SLOVAK REPUBLIC    | ● TURKEY    |
| ● BAHRAIN   | ● COLOMBIA       | ● GERMANY       | ● ISRAEL    | ● MARTINICA         | ● PERU              | ● SLOVENIA           | ● UKRAINE   |
| ● BELARUS   | ● COSTA RICA     | ● GREAT BRITAIN | ● JAPAN     | ● MAURITIUS         | ● PHILIPPINES (THE) | ● SPAIN              | ● URUGUAY   |
| ● BELGIUM   | ● CROATIA        | ● GREECE        | ● KOSOVO    | ● MONTENEGRO        | ● POLAND            | ● SRI LANKA          | ● U.S.A.    |
| ● BOSNIA    | ● CYPRUS         | ● HONG KONG     | ● LATVIA    | ● MOROCCO           | ● PORTUGAL          | ● SWEDEN             | ● VENEZUELA |
| ● BRAZIL    | ● CZECH REPUBLIC | ● HUNGARY       | ● LEBANON   | ● NETHERLANDS (THE) | ● REUNION ISLAND    | ● SWITZERLAND        | ● VIETNAM   |
| ● BULGARIA  | ● DENMARK        | ● KOREA (SOUTH) | ● LITHUANIA | ● NEW CALEDONIA     | ● ROMANIA           | ● SYRIA              |             |
| ● CAMBODIA  | ● ECUADOR        |                 |             |                     |                     |                      |             |



■ : New or Modified Item

# GENERAL SALE CONDITIONS

- The present export price-list, covering standard production equipment, replaces all previous ones.
- Goods are delivered FCA WAREHOUSE CORREGGIO - Incoterms® 2010, ICC Paris and shipped at buyer's cost.
- Standard packing is included in the price of each product.
- When ordering please always state model, quantity, power supply (Voltage, Phases, Hz) required.
- Terms of warranty: 12 months from installation date but no longer than 18 months from the date of NEXION S.p.A. invoice.
- The warranty does not cover defects or damages due to improper installation or use of products, inadequate maintenance or uncomplete knowledge of manuals supplied with the products.
- Any return of goods must always be authorized by NEXION S.p.A. and will be accepted only free our factory, custom cleared. Freight is at sender's risk.
- NEXION S.p.A. reserves the right to change the specifications of the products at any time without prior notice or obligation.

## WARNING!

For other conditions please refer to the "Distribution Agreement".



 : New or Modified Item

67

■ Compatible accessory supplied as STANDARD.  
● Compatible accessory supplied on REQUEST.

Export - May 2024





**COMPANY WITH  
CERTIFIED  
QUALITY SYSTEM  
- ISO 9001 -**

