



EFFECTIVE FROM
JANUARY 2024

EXPORT CATALOGUE
TYRE CHANGERS
AND ORIGINAL ACCESSORIES



REL. MAY 2024

COLOR TABLE

- 1) The standard company colour of our equipment is blue RAL 5015 (→ /25).
- 2) On demand other colours are available (see RAL table)*.

- Below the table for the colors:

	→ /25	RAL 5015 Blue sky
	→ /A4	RAL 5011 Blue (Peugeot)
	→ /22	RAL 5011 Blue (Peugeot) orange-peel
	→ /16	RAL 3002 Red
	→ /45	RAL 1003 Yellow (Renault)
	→ /38	RAL 7042 Grey (Renault)
	→ /39	RAL 7040 Window grey (Volkswagen / Porsche / Fiat)
	→ /33	RAL 7011 Grey (Mercedes)
	→ /65	RAL 7012 Grey (Mercedes)
	→ /52	RAL 7015 Grey (Mercedes)
	→ /69	RAL 7030 Stone grey (Ferrari / Maserati)
	→ /34	RAL 7016 Anthracite grey (BMW)

- Different colors subject to confirmation of the Export dept.

* : The equipment in different color than standard can be subject to surcharge.

The pictures included in the present illustrated catalogue, are only intended to show the product and are therefore not binding. The company reserves the right to make in every moment and without prior notice, any modification deemed necessary.

NEXION S.p.A. declines any responsibility for any complaint coming from the use of not original accessories or spares with consequent forfeiture of the CE conformity declaration.

TABLE OF CONTENTS

“LEVER-LESS” UNIVERSAL TYRE CHANGERS	5
M 1032 series	4
M 1028	7
M 928 ROYAL	8
M 830 LL	9
M 830 M	10
OPTIONAL ACCESSORIES FOR “LEVER-LESS” UNIVERSAL TYRE CHANGERS	18
“LEVER-LESS” PASSENGER CAR TYRE CHANGERS	20
M 824 LL series	20
OPTIONAL ACCESSORIES FOR M 824 LL	22
PASSENGER CAR TYRE CHANGERS	25
M 724S series	25
M 624 series	26
M 522 series	27
M 424 A series	29
M 424 series	31
M 422 series	33
M 322 FS - M 322 series	35
OPTIONAL ACCESSORIES FOR PASSENGER CAR TYRE CHANGERS	38
MOTORCYCLE TYRE CHANGERS	47
M 322 BIKE	47
OPTIONAL ACCESSORIES FOR M 322 BIKE	48
M 200 BIKE	49
OPTIONAL ACCESSORIES FOR M 200 BIKE	50
HEAVY-DUTY TYRE CHANGERS	53
F 565	52
F 562	53
F 562 M	54
F 560 - F 560 A SPECIAL	55
F 560 - F 560 A SPECIAL Y	56
F 560 A	57
F 560	58
F 260	59
F 240 A	60
F 230 MOBILE	61
F 226 MOBILE	62
OPTIONAL ACCESSORIES FOR HEAVY-DUTY TYRE CHANGERS	63
DIAGRAM OF PACKING SPECIFICATION	70

"LEVER-LESS" UNIVERSAL TYRE CHANGERS



M 1032 P.L. series

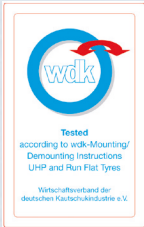

LEVER-LESS & Contact-Less
Technologies

HYDRAULIC Power

Ciclo di smontaggio
AUTOMATICO



M 1032 DIAMOND A

M 1032

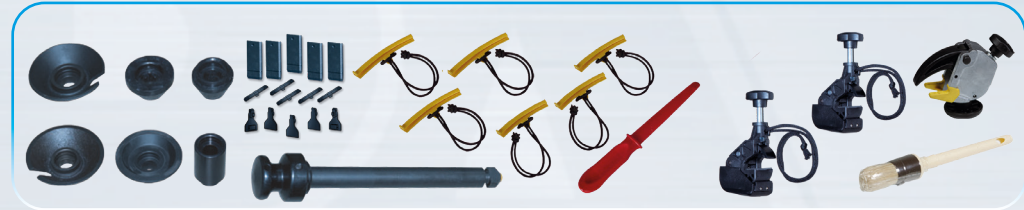

- All models supplied with:
- 1 Complete universal locking pistol
 - 1 Wheel centering cones set
 - 1 Pair of PPT plastic bead clamp
 - 3 Plastic rim protections
 - 3 Short plastic rim protections
 - 2 Bead protection plastic lever
 - 1 Set of plastic inserts for tool head (Revolver)
 - 1 Brush for bead lubrication
 - 1 Sliding bead pressing clamp
 - 1 Operator's manual

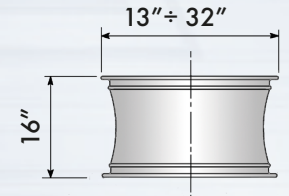

PN	Power supply	Description
0-11201306/25	200-230V/1Ph/50-60Hz	M 1032 SILVER P.L.
0-11201310/25	200-230V/1Ph/50-60Hz	M 1032 STD A P.L. - With AUTOMATIC demounting cycle.
0-11201311/25	200-230V/1Ph/50-60Hz	M 1032 SILVER A P.L. - With AUTOMATIC demounting cycle.
0-11201307/25	200-230V/1Ph/50-60Hz	M 1032 GOLD P.L.
0-11201308/25	200-230V/1Ph/50-60Hz	M 1032 DIAMOND A - With AUTOMATIC demounting cycle.



: New or Modified Item

"LEVER-LESS" UNIVERSAL TYRE CHANGERS

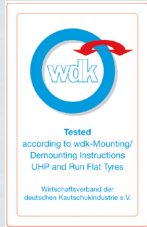

LEVER-LESS & Contact-Less
Technologies

HYDRAULIC Power



M 1032 S.L. series



- All models supplied with:
- 1 Complete universal locking pistol
 - 1 Wheel centering cones set
 - 1 Pair of PPT plastic bead clamp
 - 3 Plastic rim protections
 - 3 Short plastic rim protections
 - 2 Bead protection plastic lever
 - 1 Set of plastic inserts for tool head (Revolver)
 - 1 Brush for bead lubrication
 - 1 Sliding bead pressing clamp
 - 1 Operator's manual

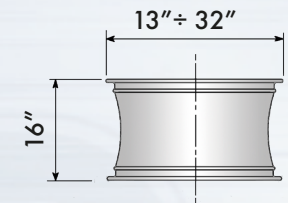

M 1032 S.L. series

PN	Power supply	Description
0-11201301/25	200 - 230V/1Ph/50-60Hz	M 1032 STD
0-11201302/25	200 - 230V/1Ph/50-60Hz	M 1032 SILVER S.L.
0-11201304/25	200 - 230V/1Ph/50-60Hz	M 1032 GOLD S.L.



: New or Modified Item

"LEVER-LESS" UNIVERSAL TYRE CHANGERS

M 1032 series SUMMARY FEATURES

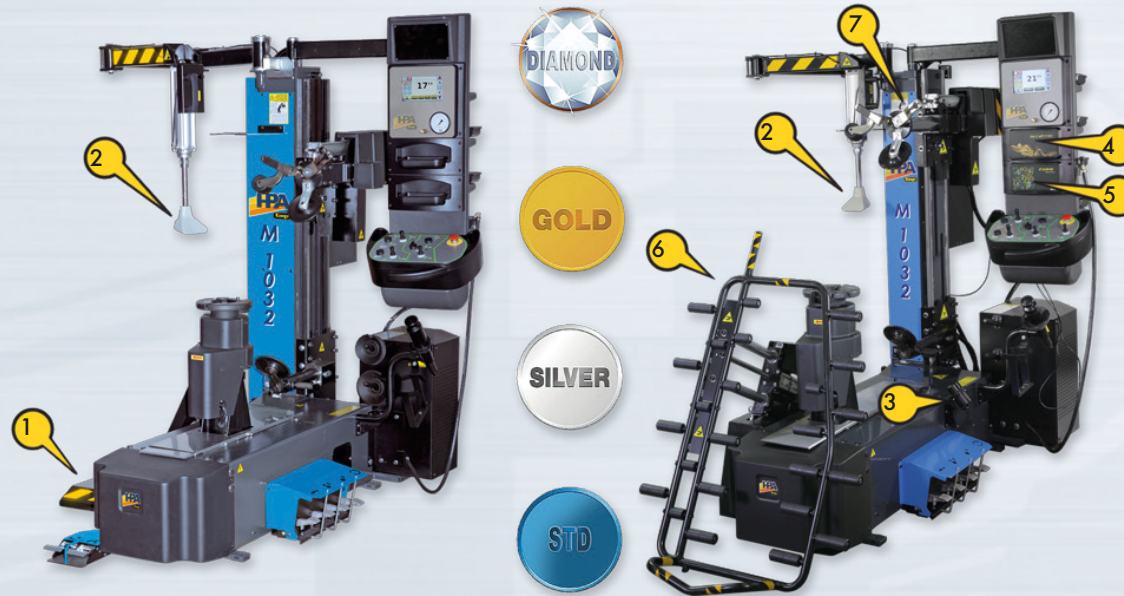

7. AUTOMATIC demounting cycle (see diagram below).

□ Versions available

M 1032 Model	STD	STD A PL.	SILVER S.L.	SILVER PL.	SILVER A PL.	GOLD S.L.	GOLD PL.	DIAMOND A
1. Side wheel lifter	☑		☑			☑		
2. Bead presser	☑	☑	☑	☑	☑	☑	☑	☑
3. Video camera			☑	☑	☑	☑	☑	☑
4. Electronic inflator						☑	☑	☑
5. TPM-02 Reader								☑
6. Front wheel lifter		☑		☑	☑		☑	☑
7. Automatic cycle		☑			☑			☑

☑ : Supplied as standard.

"LEVER-LESS" UNIVERSAL TYRE CHANGERS



M 1028

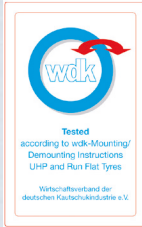

LEVER-LESS & Contact-Less
Technologies



- All models supplied with:
- 1 Complete universal locking pistol
 - 1 Set of plastic head protections
 - 1 Plastic bead clamp
 - 3 Plastic rim protections
 - 3 Short plastic rim protections
 - 1 Wheel centering cones set
 - 1 Brush for bead lubrication
 - 1 lubrication grease bucket support
 - 1 Operator's manual

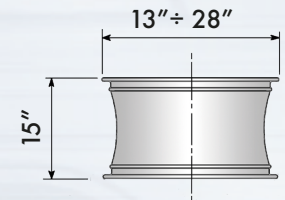

M 1028

PN	Power supply	Description
0-11212012/25	200 - 230V/1Ph/50-60Hz	M 1028 2V IP with bead pressing tool
0-11212032/25	200 - 230V/1Ph/50-60Hz	M 1028 2V IP with bead pressing tool and wheel lifter
0-11212042/25	200 - 230V/1Ph/50-60Hz	M 1028 2V IP FS with bead pressing tool and wheel lifter



: New or Modified Item

"LEVER-LESS" UNIVERSAL TYRE CHANGERS



M 928 *Royal*

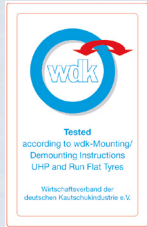

- All models supplied with:
- 1 Complete universal locking pistol
 - 1 Wheel centering cones set
 - 1 Pair of PPT plastic bead clamp
 - 3 Plastic rim protections
 - 3 Short plastic rim protections
 - 2 Bead protection plastic lever
 - 1 Set of plastic inserts for tool head
 - 1 Brush for bead lubrication
 - 1 Operator's manual

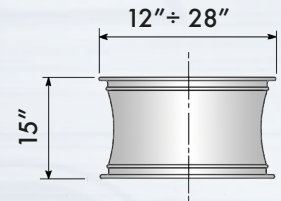

M 928 ROYAL

PN	Power supply	Description
0-11106752/25	230V/1Ph/50-60Hz	M 928 Royal + KWL28 wheel lifter - "IP" system (Increased Power System)
0-11106762/25	230V/1Ph/50-60Hz	M 928 Royal without KWL28 - "IP" system (Increased Power System)



: New or Modified Item

"LEVER-LESS" UNIVERSAL TYRE CHANGERS



M 830 LL

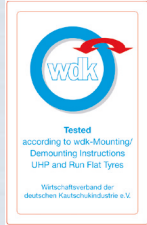

- All models supplied with:
- 1 Complete universal locking pistol
 - 1 Wheel centering cones set
 - 1 Pair of PPT plastic bead clamp
 - 3 Plastic rim protections
 - 3 Short plastic rim protections
 - 2 Bead protection plastic lever
 - 1 Set of plastic inserts for tool head
 - 1 Brush for bead lubrication
 - 1 Operator's manual

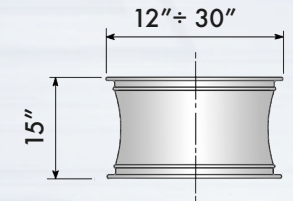

M 830 LL

PN	Power supply	Description
0-15200112/25	230V/1Ph/50-60Hz	M 830 LL + KFS 30 + KWL 30 - "IP" system (Increased Power System)
0-15200132/25	230V/1Ph/50-60Hz	M 830 LL + KWL 30 - "IP" system (Increased Power System)
0-15200102/25	230V/1Ph/50-60Hz	M 830 LL - "IP" system (Increased Power System)



: New or Modified Item

"LEVER-LESS" UNIVERSAL TYRE CHANGERS



M 830 M

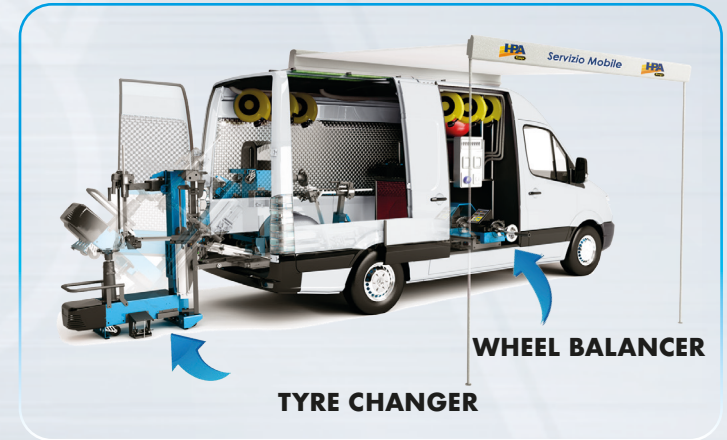
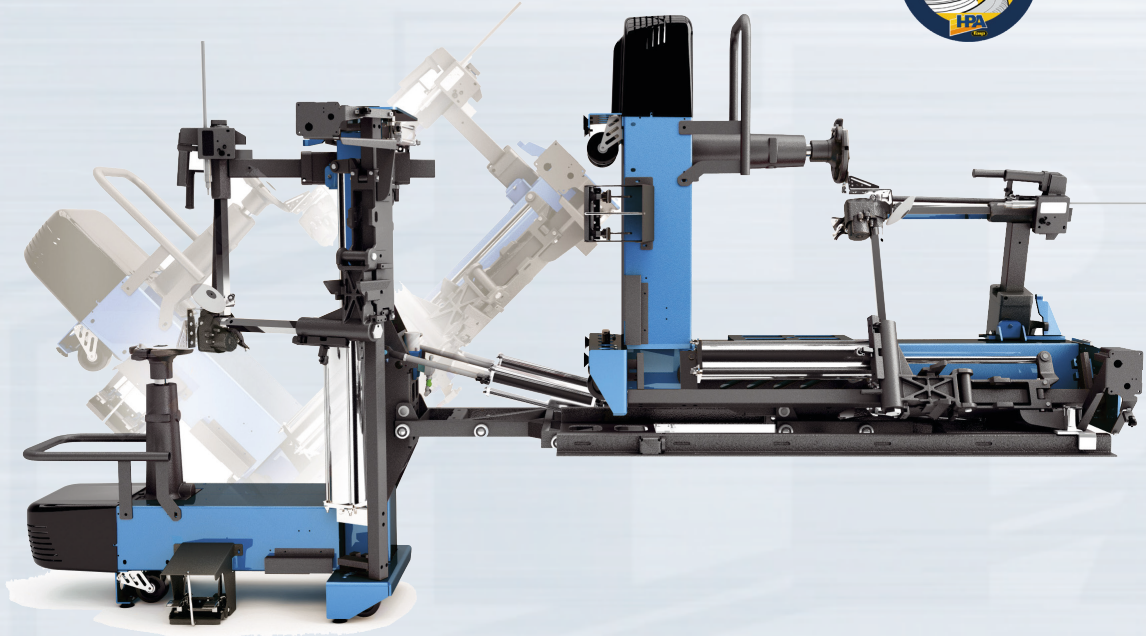

- All models supplied with:
- 1 Complete universal locking pistol
 - 1 Wheel centering cones set
 - 1 Pair of PPT plastic bead clamp
 - 3 Plastic rim protections
 - 3 Short plastic rim protections
 - 2 Bead protection plastic lever
 - 1 Set of plastic inserts for tool head
 - 1 Brush for bead lubrication
 - 1 Operator's manual

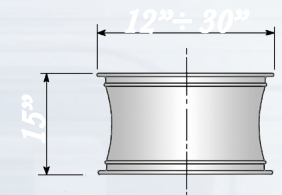





M 830 M

PN	Power supply	Description
0-15200162/25	230V/1Ph/50-60Hz	M 830 M - MOBILE SERVICE (Tilting-back slide included)
8-51100038		Power Unit Kit (Complete electric and pneumatic components for the van trimmings: battery pack + battery charger, inverter, air reservoir, rotary compressor, cables, etc.).





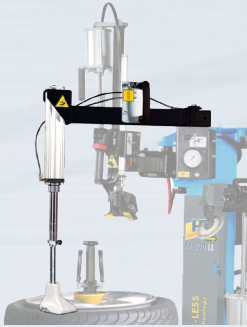

: New or Modified Item







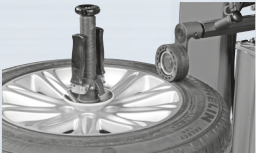

OPTIONAL ACCESSORIES FOR "LEVER-LESS" UNIVERSAL TYRE CHANGERS

PN	Picture	Description	M 1032	M 1028	M 928 ROYAL	M 830 LL	M 830 M
8-11100456		MAT TC Mobile Accessories Trolley	●	●	●	●	●
8-11100128		 PH 28 Adjustable bead pressing arm			●		
8-11100097		 PH 30 Adjustable bead pressing arm.					●

OPTIONAL ACCESSORIES FOR "LEVER-LESS" UNIVERSAL TYRE CHANGERS

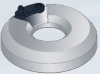
PN	Picture	Description	M 1032	M 1028	M 928 ROYAL	M 830 LL	M 830 M
8-11100404		KFS 32 Tubeless inflating device.	●				
8-15100038		ASME tubeless inflating device (for USA and Canada only)	●				
8-11120053		Quick inflating system device		●			
8-11120054		ASME tubeless inflating device (for USA and Canada only)		●			
8-11100160		KFS 28 Tubeless inflating device.			●		
8-11300041		KFS 28 Tubeless inflating device (for USA and Canada only)			●		
8-11100111		KFS 30 Tubeless inflating device.				●	
8-11100085		KWL 30 Pneumatic wheel lifter device.				●	
8-11100159		SA 28 Accessory holder support.			●		
8-11100287		AUTOLOCK II Electric rim clamping and releasing handle.			●	●	●







OPTIONAL ACCESSORIES FOR "LEVER-LESS" UNIVERSAL TYRE CHANGERS

PN	Picture	Description	M 1032	M 1028	M 928 ROYAL	M 830 LL	M 830 M
8-11100338		PAX System kit		●	●	●	●
8-11100412		KPBA Automatic locking protection kit.	■				
8-11100400		KPBM Manual locking protection kit.			■	■	■
8-11100037		Kit for light commercial vehicles and pick-up rims. Rim hole diameter: max 158 mm	●	●			
8-11100086		Kit for light commercial vehicles and pick-up rims. Rim hole diameter: max 158 mm			●	●	●
8-15100003		Special adapter kit for wide rims (H=28mm). Es. Porsche rear wheel	●	●			
8-15100040		H= 22mm spacer ring To be combined with P/N 8-11100037 / 8-11100086 / 8-15100003	●	●	●	●	●
8-11100039		FCR 28 Reverse wheel flange (maximum wheelbase 183 mm). Extensions H=100 mm	●	●	●	●	●
8-11100087		FU 28 Universal flange for closed centre and special rims.	●		●	●	●



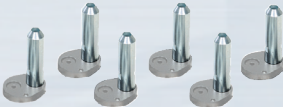





 : New or Modified Item







OPTIONAL ACCESSORIES FOR "LEVER-LESS" UNIVERSAL TYRE CHANGERS

PN	Picture	Description	M 1032	M 1028	M 928 ROYAL	M 830 LL	M 830 M
8-11100046		Extension kit for reverse wheel flange, flange for close centre rims and non standard wheel kit. H + 23 mm / Diam. 25 mm	●	●	●	●	●
8-11100244		KE 20 Set of 6 "SHORT" extensions H = 80 mm	●	●	●	●	●
8-11100245		KE 40 Set of 6 "EXTRA SHORT" extensions H = 60 mm	●	●	●	●	●
8-11100246		KE 25 Set of 6 "LONG" extensions H = 125 mm	●	●	●	●	●
8-11100284		KPC 12 Set of 12 plastic protective caps.	●	●	●	●	●
8-11100291		KEA 28 Set of 6 spherical ext. for new AUDI wheels for flange FCR 28.	●	●	●	●	●
8-11100110	 <input type="checkbox"/> = Close centre rim kit <input type="checkbox"/> = Reverse rim kit	FCS 32 Not standard rim kit.	●		●	●	●

OPTIONAL ACCESSORIES FOR "LEVER-LESS" UNIVERSAL TYRE CHANGERS

PN	Picture	Description	M 1032	M 1028	M 928 ROYAL	M 830 LL	M 830 M
8-11100038		Universal flange for special and closed centre rims		●			
8-11200002 NEW!		Kit electro-mechanic locking BMW	●				
8-15100024 NEW!		Kit pneumatic locking BMW		●			
8-15100025 NEW!		Kit manual locking BMW			●	●	●
8-15100026		Spacer H=64mm for vans (Daily)	●				
801262417		PPT Bead clamp for "Run Flat" tyres - WDK Approved.	■	■	■	■	■
801435685		UPT Universal bead clamp.		●			

OPTIONAL ACCESSORIES FOR "LEVER-LESS" UNIVERSAL TYRE CHANGERS

PN	Picture	Description	M 1032	M 1028	M 928 ROYAL	M 830 LL	M 830 M
8-11100120		Sliding bead pressing device .		●			
8-11120013		PTS Bead protection plastic lever.	■	■	■	■	■
8-11120014		REP-3 Kit of 3 plastic rim protections.	■	■	■	■	■
8-11120015		REP-3S Kit of 3 short plastic rim protections.	■	■	■	■	■
8-11400293		KPP-LL Kit of plastic inserts for "LEVER-LESS" tool head. Suitable for tyre changer with serial number up to: FMG143250			■	■	■
8-11400325		KPP-LL V3 Kit of plastic inserts for "LEVER-LESS" tool head. Suitable for tyre changer with serial number starting from: FMG143251			■	■	■

OPTIONAL ACCESSORIES FOR "LEVER-LESS" UNIVERSAL TYRE CHANGERS

PN	Picture	Description	M 1032	M 1028	M 928 ROYAL	M 830 LL	M 830 M
8-11100401	<p>x2 x2 x3 x5</p>	Protections kit for automatic locking		■			
8-11120058	<p>x5</p>	Kit of 5 protections for cones ø 145 mm		●			
8-11120083		Retractable lever kit (1 pc for each item)	●	●			
8-11100125		DRT Template for "LEVER-LESS" tool head adjustment.			●	●	●
8-11120035	<p>x3</p>	KPUL Spare tool plastic protection kit	●	●			
8-11120036	<p>x5 x5 x7</p>	TH Spare tool plastic protection kit	●	●			

OPTIONAL ACCESSORIES FOR "LEVER-LESS" UNIVERSAL TYRE CHANGERS

COMPLEMENTARY DEVICES

PN	Picture	Description	M 1032	M 928 ROYAL	M 830 LL	M 830 M
6015001300		TPM-02 TPMS Diagnostic Tool	●	●	●	●
8-64500013		OBD Kit	●	●	●	●
6015001391		TPM-02 Plus TPM-02 + OBD kit.	●	●	●	●
6015001360		TPM-02 Bluetooth printer.	●	●	●	●

OPTIONAL ACCESSORIES FOR "LEVER-LESS" UNIVERSAL TYRE CHANGERS

COMPLEMENTARY DEVICES

PN	Picture	Description	M 1032	M 928 ROYAL	M 830 LL	M 830 M
8-51100029		TPM-02 standard annual subscription.	●	●	●	●
8-51120003		TPM-02 extended annual subscription.	●	●	●	●
8-51120001		TPM-02 + EOBD annual subscription.	●	●	●	●
8-51120004		TPM-02 + EOBD extended annual subscription.	●	●	●	●



 : New or Modified Item

"LEVER-LESS" PASSENGER CAR TYRE CHANGERS



M 824 LL series

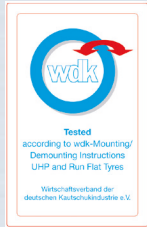

- All models supplied with:
- 1 Plastic cover for bead breaker blade
 - 1 Set of 4 jaw pads for alloy rims
 - 1 PPT plastic bead clamp
 - 3 Plastic rim protections
 - 3 Short plastic rim protections
 - 2 Bead protection plastic lever
 - 1 Set of plastic inserts for tools head
 - 1 Brush for bead lubrication
 - 1 Operator's manual



M 824 LL

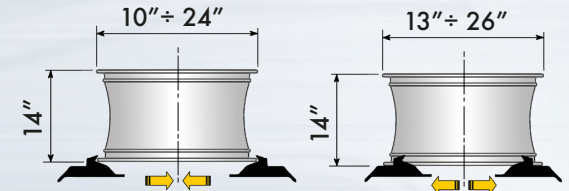

PN	Power supply	Description
0-11110422/25	230V/1Ph/50-60Hz	M 824 2V FS LL + ALLY 90 - "IP" system (Increased Power System)
0-11110522/25	230V/1Ph/50-60Hz	M 824 2V LL + ALLY 90 - "IP" system (Increased Power System)
0-11110402/25	230V/1Ph/50Hz	M 824 FS LL + ALLY 90
0-11110501/25	400V/3Ph/50Hz	M 824 LL + ALLY 90
0-11110412/25	230V/1Ph/60Hz	M 824 FS LL + ALLY 90



: New or Modified Item

PN	Power supply	Description
0-11110512/25	230V/1Ph/60Hz	M 824 LL + ALLY 90.
0-11110482/25	230V/1Ph/50-60Hz	M 824 2V FS LL
0-11110542/25	230V/1Ph/50-60Hz	M 824 2V LL
0-11110472/25	230V/1Ph/50Hz	M 824 FS LL
0-11110492/25	230V/1Ph/60Hz	M 824 FS LL
0-11110521/25	400V/3Ph/50Hz	M 824 LL







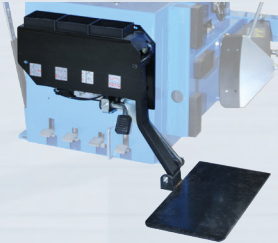

 : New or Modified Item

OPTIONAL ACCESSORIES FOR M 824 LL

PN	Picture	Description	
8-11100451		ALLY 85 Multipurpose bead lifting / pressing device. RH side. Disc version	
8-11100343		ALLY 30 Bead lifting/pressing multipurpose device	
8-11120019		ALLY 30 Customization and installation kit for M824 - M724S	
8-11400058		EFS70/W Electronic tyre inflating device for wall installation	
8-11100296		DRT 24 Template for "LEVER-LESS" tool head adjustment	
801262417		PPT Bead clamp for "Run Flat" tyres - WDK Approved	

OPTIONAL ACCESSORIES FOR M 824 LL

PN	Picture	Description
8-11100243		KWL80 Pneumatic wheel lifter device. Capacity: 80 kg.
8-11100044		PCL54 Set of 12 integral plastic jaws pads for protecting alloy rims
801258383		GPS60 Set of 6 plastic covers for bead breaker blade
8-11120013		PTS Bead protection plastic lever
8-11120014		REP-3 Kit of 3 plastic rim protections.
8-11120015		REP-3S Kit of 3 short plastic rim protections.

OPTIONAL ACCESSORIES FOR M 824 LL

PN	Picture	Description
8-11400293		KPP-LL Kit of plastic inserts for "LEVER-LESS" tool head. Suitable for tyre changer with serial number up to: FMG143250
8-11400325		KPP-LL V3 Kit of plastic inserts for "LEVER-LESS" tool head. Suitable for tyre changer with serial number starting from: FMG143251
8-11120095		Lube bracket 1-5 Kg
8-11120092		Storage tray
8-11100042		GA69 Set of adapters for 8"÷9" rims.
8-11100041		GA524 Set of adapters for increasing outside locking of 4" (alloy rims).
8-11100036		GM520 Set of motorcycle wheel adapters from 15" to 23"/25"

PASSENGER CAR TYRE CHANGERS



M 724S series



ALLY 85
available on request

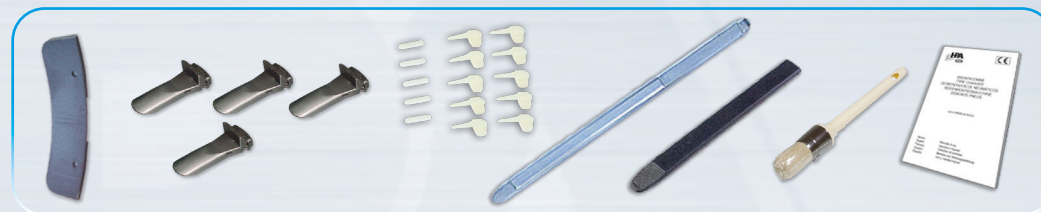

- All models supplied with:
- 1 Bead lever
 - 1 Set of 4 jaw pads for alloy rims (front/rear type)
 - 1 Plastic cover for bead breaker blade
 - 1 Plastic cover for bead lever
 - 1 Set of plastic inserts for tools head (Additional)
 - 1 Brush for bead lubrication 1 Operator's manual

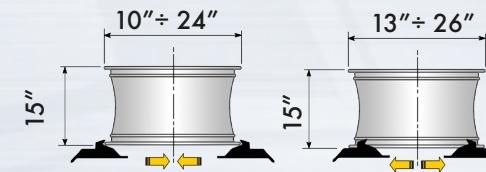

M 724S

PN	Power supply	Description	
0-11211302/25	200-230V/1Ph/50-60Hz	M 724S 2V IP FS	
0-11211301/25	400V/3Ph/50Hz	M 724S FS	
0-11211312/25	200-230V/1Ph/50	M 724S FS	
0-11211322/25	200-230V/1Ph/60	M 724S FS	
0-11211202/25	200-230V/1Ph/50-60Hz	M 724S 2V IP	
0-11211201/25	400V/3Ph/50Hz	M 724S	
0-11211206/25	12 V	M 724S	
Versions with pneumatic tools positioning			
0-11211502/25	200-230V/1Ph/ 50-60Hz	M 724S AUTOMATIC 2V IP FS	
0-11211402/25	200-230V/1Ph/ 50-60Hz	M 724S AUTOMATIC 2V IP	



 : New or Modified Item

PASSENGER CAR TYRE CHANGERS



M 624 series



- All models supplied with:
- 1 Bead lever
 - 1 Set of 4 jaw pads for alloy rims (front/rear type)
 - 1 Plastic cover for bead breaker blade
 - 1 Plastic cover for bead lever
 - 1 Set of plastic inserts for tools head (Additional)
 - 1 Brush for bead lubrication
 - 1 Operator's manual

M 624

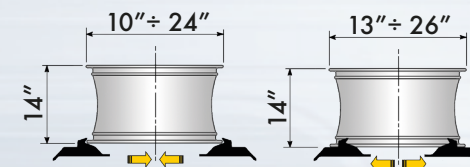

PN	Power supply	Description
0-11106322/25	230V/1Ph/50-60Hz	M 624 2V FS - "IP" system (Increased Power System)
0-11106301/25	400V/3Ph/50Hz	M 624 FS
0-11106302/25	230V/1Ph/50Hz	M 624 FS
0-11106401/25	400V/3Ph/50Hz	M 624



: New or Modified Item

PASSENGER CAR TYRE CHANGERS



M 522 series



- All models supplied with:
- 1 Bead lever
 - 1 Set of 4 jaw pads for alloy rims (front/rear type)
 - 1 Plastic cover for bead breaker blade
 - 1 Plastic cover for bead lever
 - 1 Set of plastic inserts for tools head (Additional)
 - 1 Brush for bead lubrication
 - 1 Operator's manual

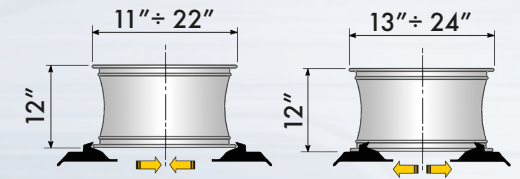

M 522

PN	Power supply	Description
0-11108441/25	400V/3Ph/50Hz	M 522 2V FS
0-11108432/25	230V/1Ph/50-60Hz	M 522 2V FS - "IP" system (Increased Power System)
0-11108451/25	230V/3Ph/60Hz	M 522 2V FS
0-11108401/25	400V/3Ph/50Hz	M 522 FS



: New or Modified Item

PN	Power supply	Description
0-11108402/25	230V/1Ph/50Hz	M 522 FS
0-11108411/25	200-230V/3Ph/50Hz	M 522 FS
0-11108421/25	200-230V/3Ph/60Hz	M 522 FS
0-11108412/25	200-230V/1Ph/60Hz	M 522 FS
0-11108341/25	400V/3Ph/50Hz	M 522 2V
0-11108332/25	230V/1Ph/50-60Hz	M 522 2V - "IP" system (Increased Power System)
0-11108301/25	400V/3Ph/50Hz	M 522
0-11108302/25	230V/1Ph/50Hz	M 522
0-11108312/25	230V/1Ph/60Hz	M 522

PASSENGER CAR TYRE CHANGERS

M 424 A series



- All models supplied with:
- 1 Bead lever
 - 1 Set of 4 jaw pads for alloy rims (front/rear type)
 - 1 Plastic cover for bead breaker blade
 - 1 Plastic cover for bead lever
 - 1 Set of plastic inserts for tools head (Additional)
 - 1 Brush for bead lubrication
 - 1 Operator's manual
 - 1 BAR/PSI inflating gun (*)
- *: Supplied for M 424 A 2V and M 424 A only.

M 424 A

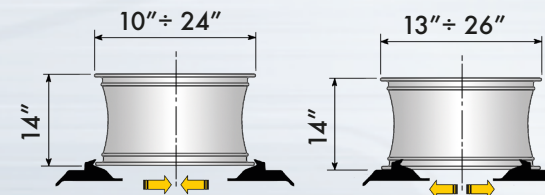

PN	Power supply	Description
0-11201641/25	400V/3Ph/50Hz	M 424 A 2V FS
0-11201632/25	200-230V/1Ph/50-60Hz	M 424 A 2V FS - "IP" system (Increased Power System)
0-11201651/25	200-230V/3Ph/60Hz	M 424 A 2V FS
0-11201601/25	400V/3Ph/50Hz	M 424 A FS



: New or Modified Item

PN	Power supply	Description
0-11201602/25	230V/1Ph/50Hz	M 424 A FS
0-11201541/25	400V/3Ph/50Hz	M 424 A 2V
0-11201551/25	200-230V/3Ph/60Hz	M 424 A 2V
0-11201532/25	200-230V/1Ph/50-60Hz	M 424 A 2V - "IP" system (Increased Power System)
0-11201501/25	400V/3Ph/50Hz	M 424 A
0-11201502/25	230V/1Ph/50Hz	M 424 A

PASSENGER CAR TYRE CHANGERS



M 424 series



- All models supplied with:
- 1 Bead lever
 - 1 Set of 4 jaw pads for alloy rims (front/rear type)
 - 1 Plastic cover for bead breaker blade
 - 1 Plastic cover for bead lever
 - 1 Set of plastic inserts for tools head (Additional)
 - 1 Brush for bead lubrication
 - 1 Operator's manual
 - 1 BAR/PSI Inflating gun (*)
- *: Supplied for M 424 2V and M 424 models only.

M 424

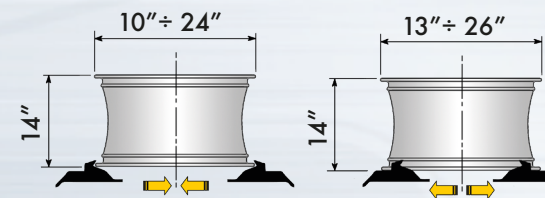

PN	Power supply	Description
0-11200841/25	400V/3Ph/50Hz	M 424 2V FS
0-11200832/25	230V/1Ph/50-60Hz	M 424 2V FS - "IP" system (Increased Power System)
0-11200851/25	200-230V/3Ph/60Hz	M 424 2V FS
0-11200801/25	400V/3Ph/50Hz	M 424 FS



: New or Modified Item

PN	Power supply	Description
0-11200802/25	230V/1Ph/50Hz	M 424 FS
0-11200812/25	230V/1Ph/60Hz	M 424 FS
0-11200811/25	200-230V/3Ph/60Hz	M 424 FS
0-11200741/25	400V/3Ph/50Hz	M 424 2V
0-11200751/25	200-230V/3Ph/60Hz	M 424 2V
0-11200732/25	230V/1Ph/50-60Hz	M 424 2V - "IP" system (Increased Power System)
0-11200701/25	400V/3Ph/50Hz	M 424
0-11200702/25	200-230V/1Ph/50Hz	M 424
0-11200712/25	200-230V/1Ph/60Hz	M 424
0-11200711/25	200-230V/3Ph/60Hz	M 424

PASSENGER CAR TYRE CHANGERS



M 422 series



- All models supplied with:
- 1 Bead lever
 - 1 Set of plastic inserts for tools head (Additional)
 - 1 Brush for bead lubrication
 - 1 Operator's manual
 - 1 BAR/PSI Inflating gun (*)
- *: Supplied for M 422 2V and M 422 models only.

M 422

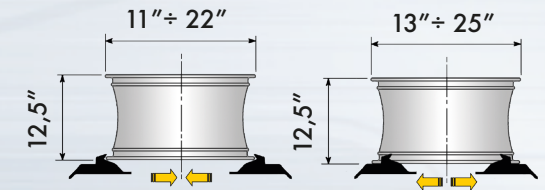

PN	Power supply	Description
0-11210941/25	400V/3Ph/50Hz	M 422 2V FS
0-11210901/25	400V/3Ph/50Hz	M 422 FS
0-11211041/25	400V/3Ph/50Hz	M 422 2V
0-11211001/25	400V/3Ph/50Hz	M 422



 : New or Modified Item

PASSENGER CAR TYRE CHANGERS

PN	Power supply	Description
0-11210932/25	230V/1Ph/50-60Hz	M 422 2V FS - "IP" system (Increased Power System)
0-11210951/25	200-230V/3Ph/60Hz	M 422 2V FS
0-11210971/25	400V/3Ph/50Hz	M 422 2V FS BAR
0-11210902/25	230V/1Ph/50Hz	M 422 FS
0-11210912/25	230V/1Ph/60Hz	M 422 FS
0-11210911/25	200-230V/3Ph/60Hz	M 422 FS
0-11210961/25	400V/3Ph/50Hz	M 422 FS BAR
0-11211051/25	200-230V/3Ph/60Hz	M 422 2V
0-11211032/25	230V/1Ph/50-60Hz	M 422 2V - "IP" system (Increased Power System)
0-11211002/25	200-230V/1Ph/50Hz	M 422
0-11211012/25	230V/1Ph/60Hz	M 422
0-11211011/25	200-230V/3Ph/60Hz	M 422

PASSENGER CAR TYRE CHANGERS



M 322 FS - M 322



- All models supplied with:
- 1 Bead lever
 - 1 Set of plastic inserts for tools head (Additional)
 - 1 Brush for bead lubrication
 - 1 Operator's manual
 - 1 BAR/PSI Inflating gun (*)
- *: Supplied for M 322 models only.

M 322 FS - M 322

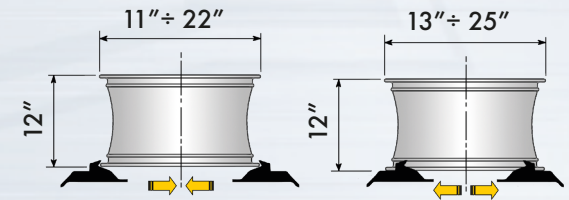

PN	Power supply	Description	
0-11201001/25	400V/3Ph/50Hz	M 322 FS	
0-11201002/25	200-230V/1Ph/50Hz	M 322 FS	
0-11200901/25	400V/3Ph/50Hz	M 322	
0-11200902/25	200-230V/1Ph/50Hz	M 322	
0-11200912/25	200-230V/1Ph/60Hz	M 322	
0-11200906/25	12 V	M 322	



: New or Modified Item

OPTIONAL ACCESSORIES FOR PASSENGER CAR TYRE CHANGERS

COMPLEMENTARY DEVICES

PN	Picture	Description
6015001300		TPM-02 TPMS Diagnostic Tool.
8-64500013		OBD Kit
6015001391		TPM-02 Plus TPM-02 + OBD kit.
6015001360		TPM-02 Bluetooth printer.

OPTIONAL ACCESSORIES FOR PASSENGER CAR TYRE CHANGERS



COMPLEMENTARY DEVICES

PN	Picture	Description
8-51100029		TPM-02 standard annual subscription.
8-51120003		TPM-02 extended annual subscription.
8-51120001		TPM-02 + EOBD annual subscription.
8-51120004		TPM-02 + EOBD extended annual subscription.

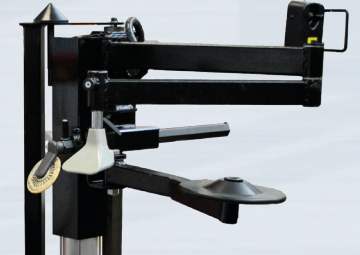





OPTIONAL ACCESSORIES FOR PASSENGER CAR TYRE CHANGERS

PN	Picture	Description	M 724S series	M 624 series	M 522 series	M 424 series	M 422 series	M 322 series	M 322 Bike
8-11400211		ALLY 80 Universal bead lifting / pressing device.		●	●				
8-11100451		ALLY 85 Multipurpose bead lifting / pressing device.	●						
8-11200003		ALLY 85 Multipurpose bead lifting / pressing device.				●			

OPTIONAL ACCESSORIES FOR PASSENGER CAR TYRE CHANGERS

PN	Picture	Description	M 724S series	M 624 series	M 522 series	M 424 series	M 422 series	M 322 series	M 322 Bike
8-11100153		Extension for bead pressing cone				●	●		
8-11100343		ALLY 30 Bead lifting/pressing multipurpose device.	●	●	●	●	●		
8-11100363		ALLY 30 Customization and installation kit for M624/M522 series		●	●				
8-11200004		ALLY 30 Customization and installation kit for M 424 series				●			
8-11220006		ALLY 30 Customization and installation kit for M 422 series					●		
8-11120019		ALLY 30 Customization and installation kit for M824 - M724S		●					
8-11120032		BPL Bead pressing device with one tool arm. LH side installation.					●	●	●





OPTIONAL ACCESSORIES FOR PASSENGER CAR TYRE CHANGERS

PN	Picture	Description	M 724S series	M 624 series	M 522 series	M 424 series	M 422 series	M 322 series	M 322 Bike
801276833		PGM Michelin tyre inflating gun BAR scale - EC Homologated.			●				
801281796		PGE Economic tyre inflating gun BAR scale - EC Homologated.			●				
801281797		PGM2 Michelin tyre inflating gun with BAR / PSI scales.			●				
801271621		PGE2 Economic tyre inflating gun with both BAR and PSI scales.			●				
8-51120007		ASTURO BAR/PSI inflating gun				●			
8-11400058		EFS70/W Electronic tyre inflating device for wall installation	●	●	●	●	●		





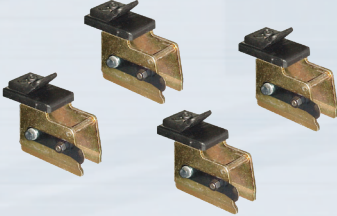
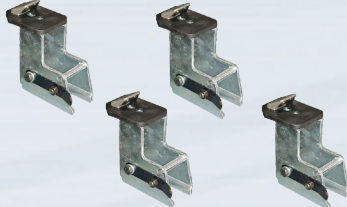

OPTIONAL ACCESSORIES FOR PASSENGER CAR TYRE CHANGERS

PN	Picture	Description	M 724S series	M 624 series	M 522 series	M 424 series	M 422 series	M 322 series	M 322 Bike
8-11100243		KWL80 Pneumatic wheel lifter device. Capacity: 80 kg.	●	●	●				
8-11220007		KWL60 Pneumatic wheel lifter device. Capacity: 60 kg.				●	●	●	●
801262417		PPT Bead clamp for "Run Flat" tyres - WDK Approved.	●	●	●	●	●	●	●
801435685		UPT Universal bead clamp.	●	●	●	●	●	●	●
8-11100120		Sliding bead pressing device .	●	●	●	●	●	●	●

OPTIONAL ACCESSORIES FOR PASSENGER CAR TYRE CHANGERS

PN	Picture	Description	M 724S series	M 624 series	M 522 series	M 424 series	M 422 series	M 322 series	M 322 Bike
8-11400290		PTR Roller bead pressing device for “Run Flat” and UHP tyres.	●	●	●	●	●	●	●
8-11100042		GA69 Set of adapters for 8”÷9” rims.	●	●	●	●	●	●	
8-11100041		GA524 Set of adapters for increasing outside locking of 4” (alloy rims).	●	●	●	●	●	●	
8-11100036		GM520 Set of motorcycle wheel adapters from 15” to 23”/25”	●	●	●	●	●	●	
8-11120027		Special bead breaker blade for motorcycle wheels.	●	●	●	●	●	●	

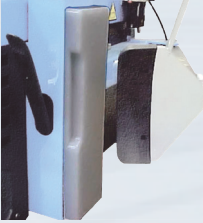



OPTIONAL ACCESSORIES FOR PASSENGER CAR TYRE CHANGERS

PN	Picture	Description	M 724S series	M 624 series	M 522 series	M 424 series	M 422 series	M 322 series	M 322 Bike
8-11100044		PCL54 Set of 12 integral plastic jaws pads for protecting alloy rims.	●	■	■	■	●	●	
063905800		PPC Plastic protections for clamps (20 pcs)	●	●	●	●	●	●	
801254341		PS10 Set of 10 special plastic inserts for tool head.		■	■	■	■	■	■
801258898		PTH5 Set of 5 special plastic pads for tool head		■	■	■	■	■	■
801458663		PTS60 Plastic cover for side bead breaker				●	●	●	
801258383		GPS60 Set of 6 plastic covers for bead breaker blade	●	■	■	■	●	●	

OPTIONAL ACCESSORIES FOR PASSENGER CAR TYRE CHANGERS

PN	Picture	Description	M 724S series	M 624 series	M 522 series	M 424 series	M 422 series	M 322 series	M 322 Bike
801246241		KGL6 Kit of 6 plastic covers for tyre lever to protect alloy rims.	■	■	■	■	●	●	●
8-11120050		TAM/WING Steel tool head for cars and motorcycles (starting from serial # FRD267085)	■			●	●	●	●
8-11100369		MPK5 Set of 10+10 plastic inserts for TAM/WING tool head	●			●	●	●	●
801250309		TCL40 Plastic tool head		●	●				
8-11400329		TPA/WING Full assembly plastic tool-head kit with adapter (starting from serial #FRD267085)	●			●	●	●	●
8-11400334		TPA/WING Full assembly plastic tool-head kit with adapter (before serial #FRD267085) For M 522 and M 624 always installable.	●	●	●	●	●	●	●
8-11400330		TPA-Wing single plastic tool-head	●			●	●	●	●

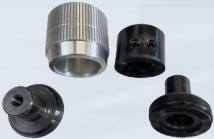
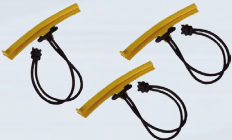
OPTIONAL ACCESSORIES FOR PASSENGER CAR TYRE CHANGERS

PN	Picture	Description	M 724S series	M 624 series	M 522 series	M 424 series	M 422 series	M 322 series	M 322 Bike
8-11100378		TMN Mounting/demounting tool head for scooter wheels. Complete with plastic alloy rim protections (starting from serial #FRD267085)	●			●	●	●	●
8-11100370	IMAGE NOT AVAILABLE	MPK6 Protection kit for new scooters m/d head (for TMN scooter)	●			●	●	●	●
801252083		Scooter m/d head tool for 8" rims (up to serial #FRD267084)		●	●				
8-11100001		M/D head tool fast fitting kit (up to serial #FRD267084)		●	●				
8-11120089		Kit quick change tool head (starting from serial # FRD267085)	●			●	●	●	●
8-11120014		REP-3 Kit of 3 plastic rim protections	●	●	●	●	●	●	●
8-11120015		REP-3S Kit of 3 short plastic rim protections	●	●	●	●	●	●	●

OPTIONAL ACCESSORIES FOR PASSENGER CAR TYRE CHANGERS

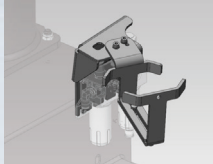
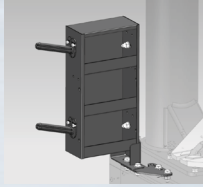
PN	Picture	Description	M 724S series	M 624 series	M 522 series	M 424 series	M 422 series	M 322 series	M 322 Bike
8-11120028/90		PWR Roller board for bead breaker. To fix to the floor.	●	●	●	●	●	●	●
8-11120095		Lube bracket 1-5 Kg	●	●	●	●		●	●
8-11120092		Storage tray	●			●	●	●	●

MOTORCYCLE TYRE CHANGERS



M 322 BIKE



- All models supplied with:
- 1 Bead lever
 - 1 Set of plastic inserts for tools head (Additional)
 - 1 Brush for bead lubrication
 - 1 Operator's manual
 - 1 BAR/PSI Inflating gun (*)
- *: Supplied for M 322 models only.

M 322 BIKE

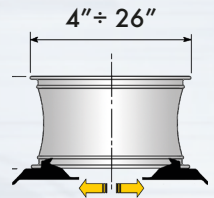

PN	Power supply	Description	
0-11211601/25	400V/3Ph/50Hz	M 322 BIKE	
0-11211602/25	230V/3Ph/50Hz	M 322 BIKE	
0-11211603/25	230V/1Ph/50Hz	M 322 BIKE	
0-11211604/25	230V/1Ph/60Hz	M 322 BIKE	
0-11211605/25	115V/1Ph/60Hz	M 322 BIKE	



 : New or Modified Item

OPTIONAL ACCESSORIES FOR M 322 BIKE

PN	Picture	Description
8-11100461		Racing bike turntable jaw kit 8" - 26"
8-11100462		ATV turntable jaw kit 5"-18"
8-11100463		Removable platform for bike wheels

MORE ACCESSORIES FOR MODEL M 322 BIKE ARE AVAILABLE IN THE CAR TYRE CHANGER ACCESSORIES SECTION

MOTORCYCLE TYRE CHANGERS



M 200 BIKE



- All models supplied with:
- 1 Bead lever
 - 1 Plastic cover for bead lever
 - 1 Plastic cover for bead breaker blade
 - 1 Set of 4 plastic adapters for go-kart wheels
 - 1 Set of plastic inserts for tools head (Additional)
 - 1 Brush for bead lubrication
 - 1 BAR/PSI Inflating gun
 - 1 Operator's manual

M 200 BIKE

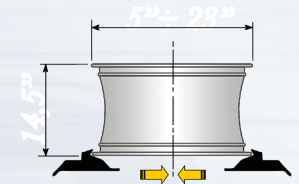

PN	Power supply	Description
0-11613401/25	230V/1Ph/50Hz	M 200 BIKE
0-11613405/25	400V/3Ph/50Hz	M 200 BIKE
0-11613414/25	115V/1Ph/60Hz	M 200 BIKE



 : New or Modified Item

OPTIONAL ACCESSORIES FOR M 200 BIKE

PN	Picture	Description
8-11600020		PPM Set of 6 plastic covers for bead breaker blade.
8-11600116		SR Wheel holder arm set.
8-11600117		PR Roller for fitting wheels smaller than 8"
8-11600118		UCA Set of 4 adapters for cross wheels.
8-11600119		ATV A Set of 4 adapters for ATV wheels (From 6" to 16")
8-11600120		ATV C Centering cone for ATV wheels (only with SR wheel holder arm).

OPTIONAL ACCESSORIES FOR M 200 BIKE

PN	Picture	Description
8-11600121		CKM Set of 4 clamping jaws
8-11600122		GKS Set of plastic covers
8-11600123		GK Set of 4 adapters for go-kart wheels
8-11600124		PO Tray
8-11600125		TG1 1 kg. lubrication grease bucket
8-11600126		IG Tyre inflating gun with BAR scale on pressure gauge. EC Homologated

HEAVY-DUTY TYRE CHANGERS



F 565



Stand by

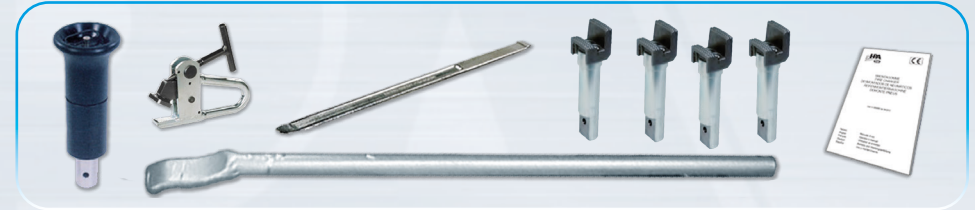

- Supplied with:
- 1 60" jaw set (4 pcs.)
 - 1 Roller for tubeless
 - 1 Bead lifting lever
 - 1 Rim ring lever
 - 1 Rim clamp
 - 1 Operator's manual

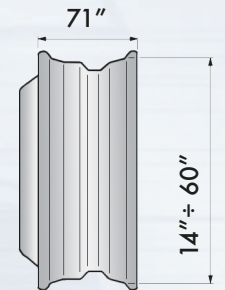

F 565

PN	Power supply	Description
0-12455001/25	400V/3Ph/50Hz	F 565
0-12455002/25	230V/3Ph/60Hz	F 565
0-12455003/25	400V/3Ph/60Hz	F 565



: New or Modified Item

HEAVY-DUTY TYRE CHANGERS



F 562

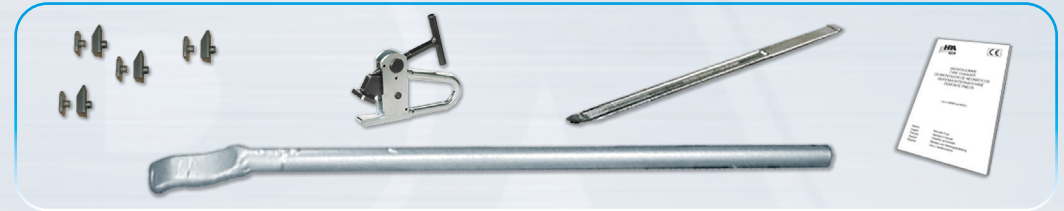

- Supplied with:
- 1 Bead lifting lever
 - 1 Rim ring lever
 - 1 Rim clamp
 - 1 Set of 4+4 special plastic inserts for jaw
 - 1 Operator's manual

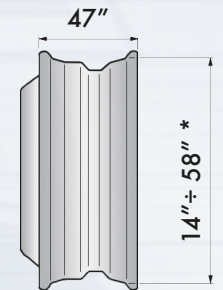

*: with PA4V extensions

F 562

PN	Power supply	Description
0-12440126/25	400V/3Ph/50Hz	F 562
0-12440128/25	230V/3Ph/50Hz	F 562



 : New or Modified Item

HEAVY-DUTY TYRE CHANGERS



F 562 M

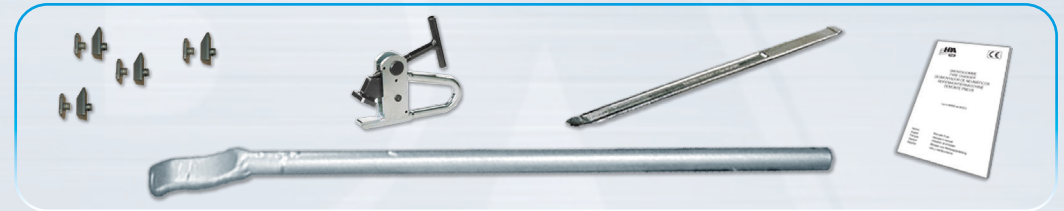
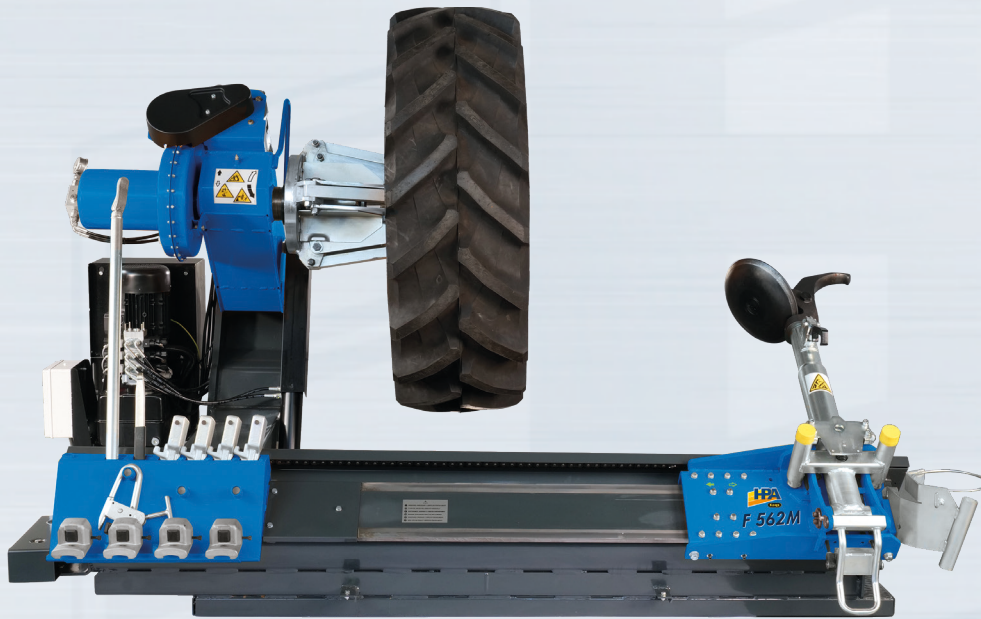

- Supplied with:
- 1 Bead lifting lever
 - 1 Rim ring lever
 - 1 Rim clamp
 - 1 Set of 4+4 special plastic inserts for jaw
 - 1 Operator's manual

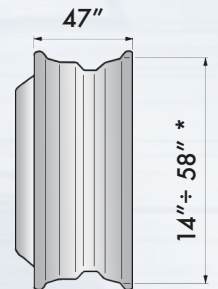

*: with PA4V extensions

F 562 M

PN	Power supply	Description
0-12400701/25	400V/3Ph/50Hz	F 562 M



: New or Modified Item

HEAVY-DUTY TYRE CHANGERS



F 560 A Special F 560 Special

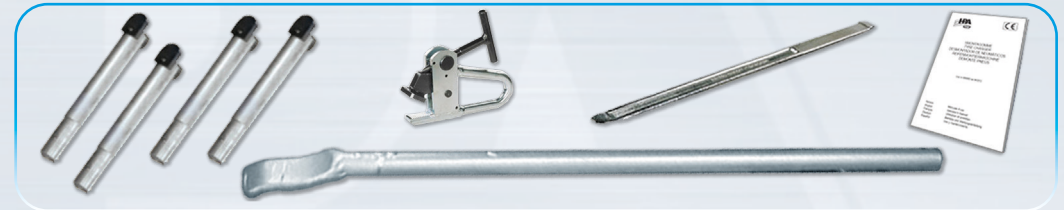

- Supplied with:
- 1 Extensions kit 56" (4 pcs)
 - 1 Bead lifting lever
 - 1 Rim ring lever
 - 1 Rim clamp
 - 1 Operator's manual

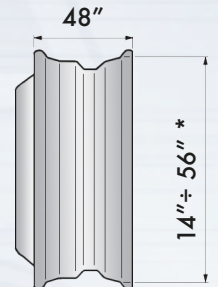

*: with KP56 extensions

F 560 - F 560 A SPECIAL

PN	Power supply	Description
0-12453005/25	400V/3Ph/50Hz	F 560 A SPECIAL
0-12453006/25	230V/3Ph/60Hz	F 560 A SPECIAL
0-12453001/25	400V/3Ph/50Hz	F 560 SPECIAL
0-12453002/25	230V/3Ph/60Hz	F 560 SPECIAL



: New or Modified Item

HEAVY-DUTY TYRE CHANGERS



F 560 A Special Y F 560 Special Y

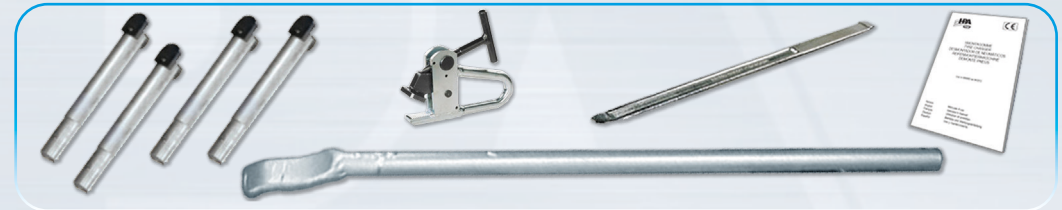
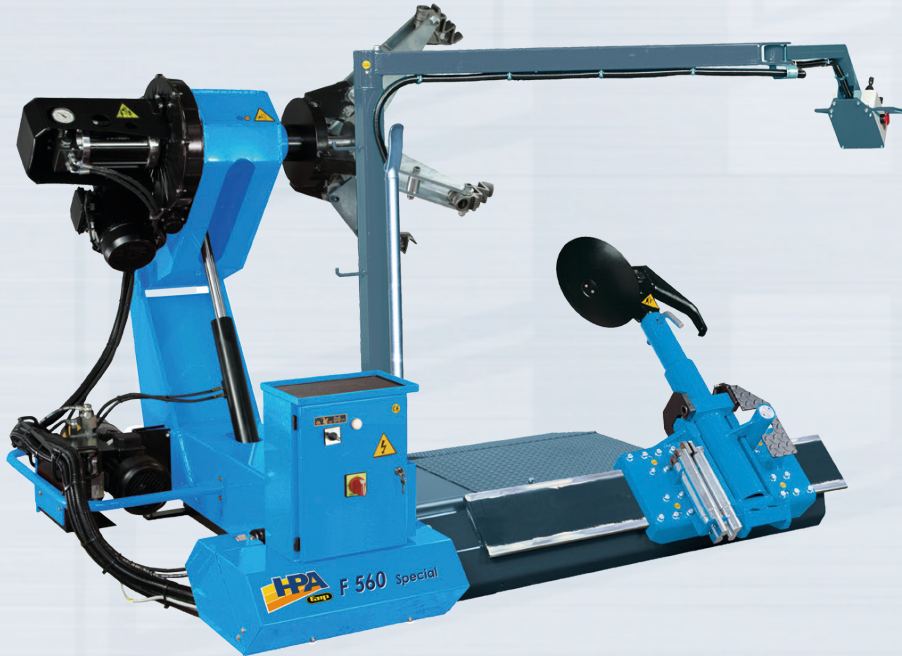

Supplied with:
 1 Extensions kit 56" (4 pcs)
 1 Bead lifting lever
 1 Rim ring lever
 1 Rim clamp
 1 Operator's manual

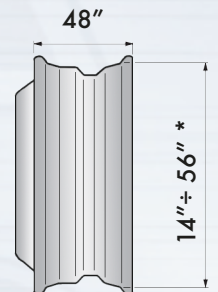

*: with KP56 extensions

F 560 - F 560 A SPECIAL Y

PN	Power supply	Description
0-12453007/25	400V/3Ph/50Hz	F 560 A SPECIAL Y
0-12453008/25	230V/3Ph/60Hz	F 560 A SPECIAL Y
0-12453003/25	400V/3Ph/50Hz	F 560 SPECIAL Y
0-12453004/25	230V/3Ph/60Hz	F 560 SPECIAL Y



: New or Modified Item

HEAVY-DUTY TYRE CHANGERS



F 560 A

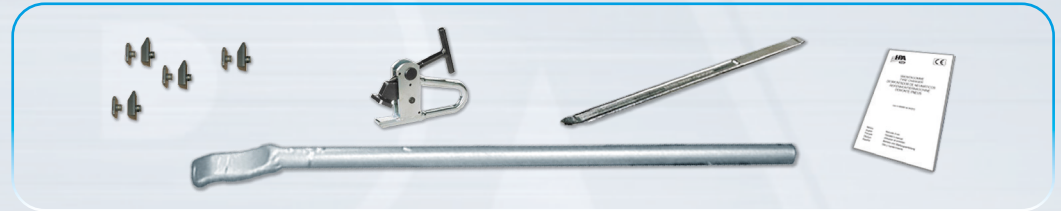

- Supplied with:
- 1 Bead lifting lever
 - 1 Rim ring lever
 - 1 Rim clamp
 - 1 Set of 4+4 special plastic inserts for jaw
 - 1 Operator's manual

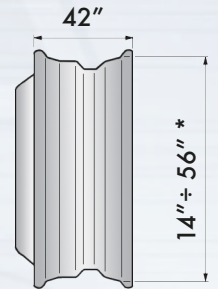

*: with PA4V extensions

F 560 A

PN	Power supply	Description
0-12200501/25	400V/3Ph/50Hz	F 560 A
0-12200502/25	230V/3Ph/60Hz	F 560 A
0-12200503/25	400V/3Ph/60Hz	F 560 A
0-12200504/25	230V/3Ph/50Hz	F 560 A



: New or Modified Item

HEAVY-DUTY TYRE CHANGERS



F 560

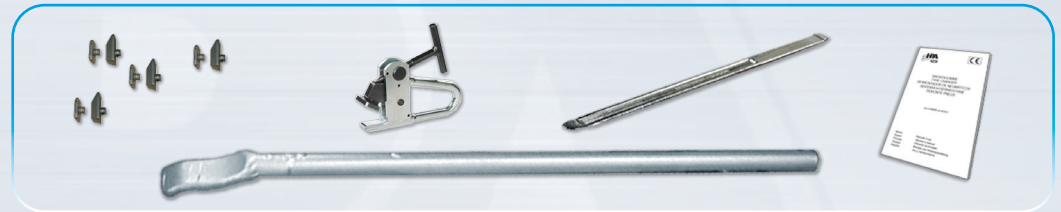
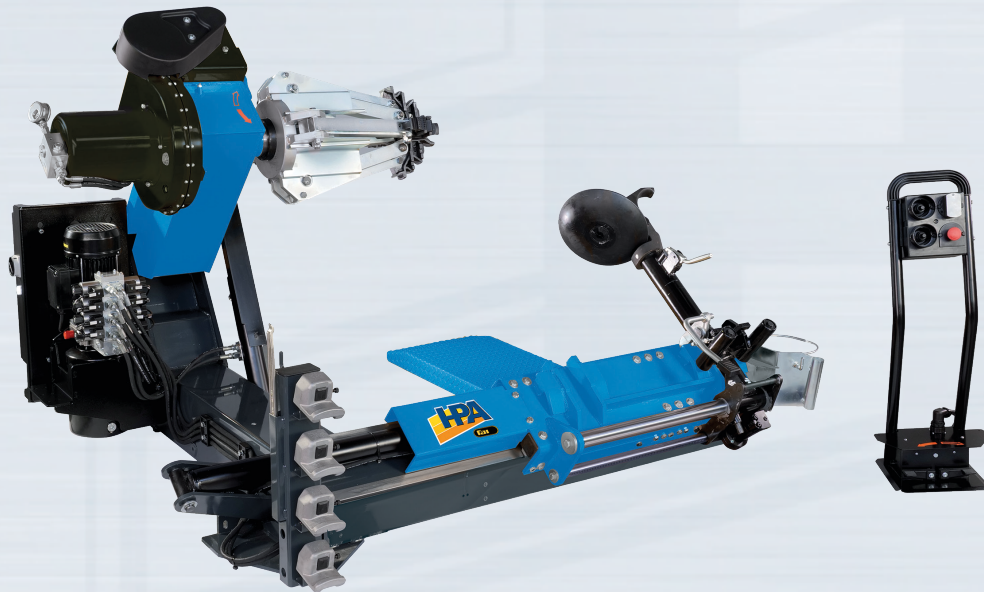

- Supplied with:
- 1 Bead lifting lever
 - 1 Rim ring lever
 - 1 Rim clamp
 - 1 Set of 4+4 special plastic inserts for jaw
 - 1 Operator's manual

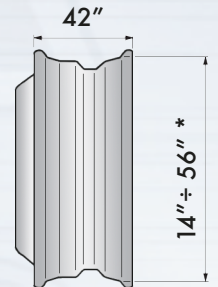

*: with PA4V extensions

F 560

PN	Power supply	Description
0-12200401/25	400V/3Ph/50Hz	F 560
0-12200402/25	230V/3Ph/60Hz	F 560
0-12200403/25	400V/3Ph/60Hz	F 560
0-12200404/25	230V/3Ph/50Hz	F 560



: New or Modified Item

HEAVY-DUTY TYRE CHANGERS



F 260

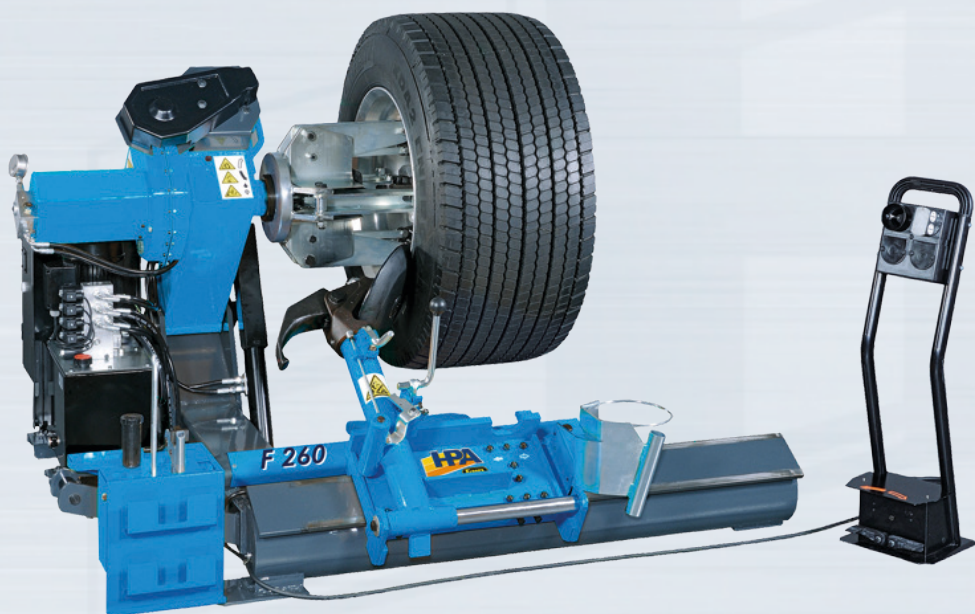

- Supplied with:
- 1 Bead lifting lever
 - 1 Rim ring lever
 - 1 Rim clamp
 - 1 Set of 4+4 special plastic inserts for jaw
 - 1 Operator's manual

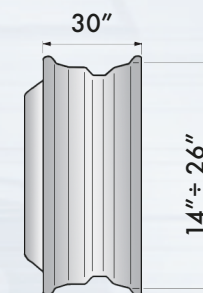

F 260

PN	Power supply	Description
0-12423019/25	400V/3Ph/50Hz	F 260
0-12423021/25	230V/3Ph/60Hz	F 260
0-12423023/25	230V/1Ph/60Hz	F 260



: New or Modified Item

HEAVY-DUTY TYRE CHANGERS



F 240 A

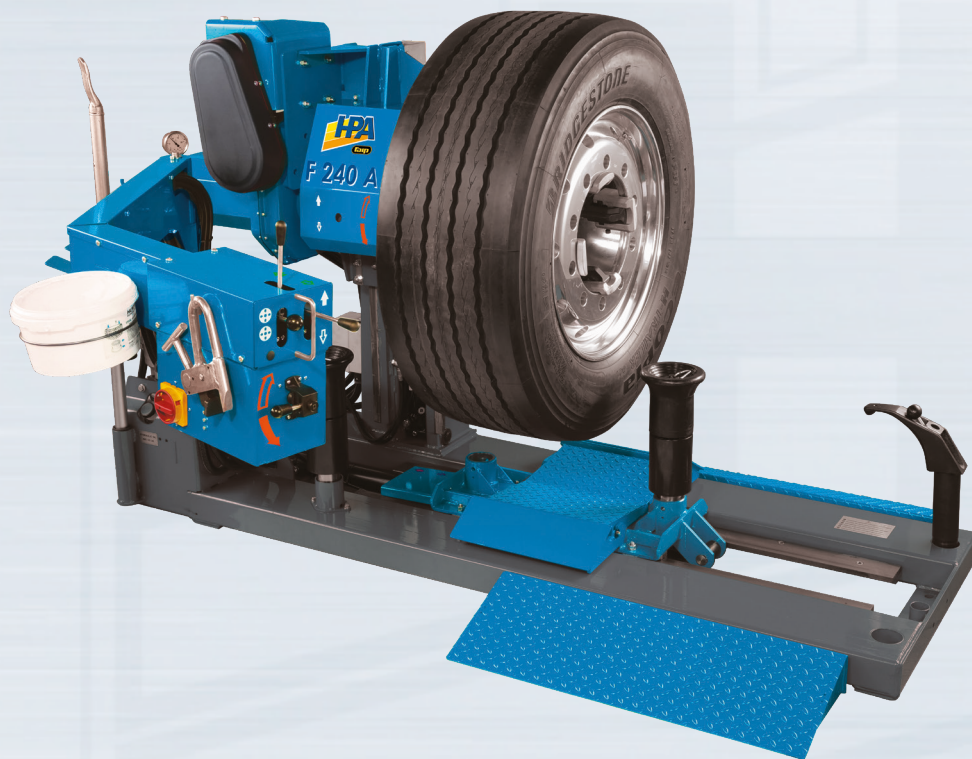

- Supplied with:
- 2 Rollers for tubeless
 - 1 Bead levering tool
 - 1 Bead lifting lever
 - 1 Rim clamp
 - 1 Operator's manual

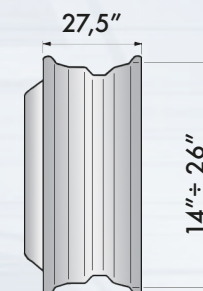

F 240 A

PN	Power supply	Description
0-12200105/25	400V/3Ph/50Hz	F 240 A
0-12200106/25	230V/3Ph/60Hz	F 240 A
0-12200107/25	230V/1Ph/50Hz	F 240 A
0-12200108/25	230V/1Ph/60Hz	F 240 A



: New or Modified Item

HEAVY-DUTY TYRE CHANGERS



F 230 Mobile

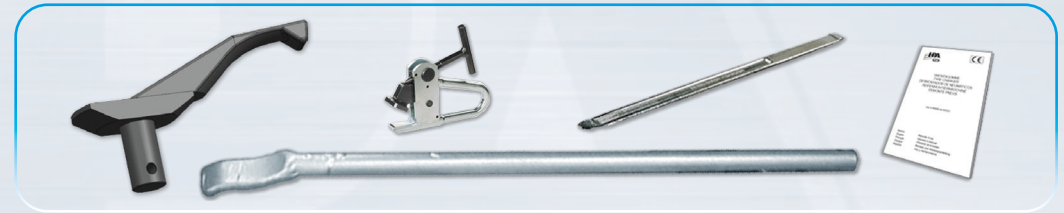

- Supplied with:
- 1 Bead levering tool
 - 1 Bead lifting lever
 - 1 Rim ring lever
 - 1 Rim clamp
 - 1 Operator's manual

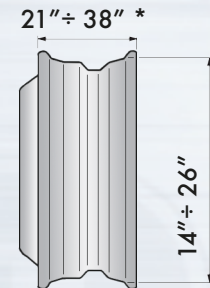

*: Depends on wheel geometry

F 230 MOBILE

PN	Power supply	Description
0-12200301/25	400V/3Ph/50Hz	F 230 Mobile for van installation - Complete with generator.
0-12200201/25	400V/3Ph/50Hz	F 230 Mobile for van installation - Without generator.



: New or Modified Item

HEAVY-DUTY TYRE CHANGERS



F 226 Mobile



- Supplied with:
- 1 Bead lever for cars
 - 1 Bead lifting lever
 - 1 Rim ring lever
 - 2 Plastic covers for bead lever
 - 1 series of locking adapters for alloy rims
 - 1 Accessory for cars and vans
 - 1 Rim clamp
 - 1 Brush
 - 1 Manual lube pump
 - 1 Operator's manual

20" ÷ 37" *

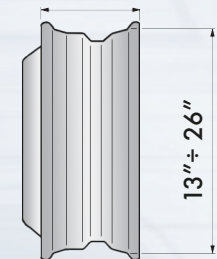

*: Depends on wheel geometry





F 226 MOBILE

PN	Power supply	Description
0-12101901/16	380V/3Ph/50Hz	F 226 Mobile RAL 3002 for van installation - Complete with generator.
0-12102201/16	380V/3Ph/50Hz	F 226 Mobile RAL 3002 for van installation - Without generator.
8-12100003		Customization Kit

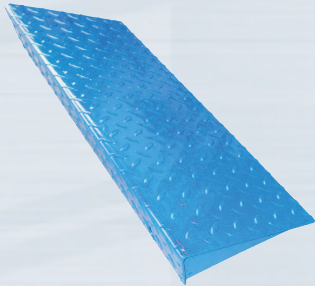

: New or Modified Item







OPTIONAL ACCESSORIES FOR HEAVY-DUTY TYRE CHANGERS

PN	Picture	Description	F 565	F 562 - F 562 M	F 560 Special	F 560 A . F 560	F 260	F 240 A	F 230 Mobile	F 226 Mobile
8-12100039/25		PC240 carriage platform						●		
8-12100040/25		PT240 ramp						●		
8-12400014		2.4 Ghz Trolley Multichannel radio remote control kit. PLC Technology. compatible up to serial number: FUC272747		●						
8-12120025/00		Radio Remote control kit for F560, F560A, F562 and F562M F 560 A / F 560 compatible starting from serial number: FRCxxxxxx F 562 compatible starting from serial number: FUDxxxxxx		●		●				
8-12100026		SGP Radio remote control for F 560 A Special and F 560 A Special Y only.			●					

OPTIONAL ACCESSORIES FOR HEAVY-DUTY TYRE CHANGERS

PN	Picture	Description	F 565	F 562 - F 562 M	F 560 Special	F 560 A . F 560	F 260	F 240 A	F 230 Mobile	F 226 Mobile
801271597		MV50/2 Pair of bead clamps	●	●	●	●				
801271609		RT50/2 Roller for tubeless.				●	●			
801280918		RT56 Roller for tubeless.		●						
19120014		RT Roller for tubeless.			●					
19120016		RT56 Y Roller for tubeless with bearings. High performance			●					
8-12100156		GL4V Set of 4 alloy rim clamps for new "4V" self-centering chuck (for F240A starting from serial number FRE300447)		●		●	●	●		
8-12100175		KGL56 Set of 4 clamps for alloy rims.	●		●					
801227195		PL56 Clamp for alloy rims.	●	●	●	●	●	●	●	●

OPTIONAL ACCESSORIES FOR HEAVY-DUTY TYRE CHANGERS

PN	Picture	Description	F 565	F 562 - F 562 M	F 560 Special	F 560 A . F 560	F 260	F 240 A	F 230 Mobile	F 226 Mobile
8-12100155		PA4V Set of 4 extensions for new "4V" self-centering chuck.		●		●				
8-12100171	 x4	P4P Set of four 4-point extensions for wheel with side ring.	●		●					
8-12100172		SPIG Set of 8 + 8 spare plastic inserts for new "4V" steel clamps.			■	■	■			
8-11400200		SPI set of 4 + 4 + 4 spare plastic inserts for KGL56 set of 4 clamps for alloy rims.			■					
801217615		LA24 Bead lifting lever.	■	■	■	■	■	■	■	■
801417620		LC24 Rim ring lever.	■	■	■	■	■	●	■	■

OPTIONAL ACCESSORIES FOR HEAVY-DUTY TYRE CHANGERS

PN	Picture	Description	F 565	F 562 - F 562 M	F 560 Special	F 560 A . F 560	F 260	F 240 A	F 230 Mobile	F 226 Mobile
8-12100188		Extensions kit for port crane rims	●		●	●				
8-12100005		AB164 Locking adapter for alloy rims D.164.	●	●	●	●	●	●	●	●
8-12100006		AB176 Locking adapter for alloy rims D.176.	●	●	●	●	●	●	●	●
8-12100007		AB161 Locking adapter for alloy rims D.161.	●	●	●	●	●	●	●	●
8-12100008		AB202 Locking adapter for alloy rims D.202.	●	●	●	●	●	●	●	●
8-12300001		AB220 Locking adapter for alloy rims D.220.	●	●	●	●	●	●	●	●
8-12100009		AB221 Locking adapter for alloy rims D.221.	●	●	●	●	●	●	●	●
8-12100010		AB281 Locking adapter for alloy rims D.281.	●	●	●	●	●	●	●	●
8-12100176		PA26 Set of four chuck extensions (for F240A up to serial number FRE300446)						●	●	
801254494		PCL26 Set of four alloy rim protections (for F240A up to serial number FRE300446)						●	●	
801251904		Skidder clamp	●	●	●	●	●	●		

OPTIONAL ACCESSORIES FOR HEAVY-DUTY TYRE CHANGERS

PN	Picture	Description	F 565	F 562 - F 562 M	F 560 Special	F 560 A . F 560	F 260	F 240 A	F 230 Mobile	F 226 Mobile
8-12100044		3 rim edge plastic protections	●	●	●	●	●	●	●	●
801289439		RT24 Roller for tubeless.	■					■		
801289440		UB24 Bead levering tool.						■		
801289441		DS24 Bead breaking disc.						●		
8-12100030		DS226 Bead breaking disc for rim ring for F 226/230 Mobile.							●	●
8-12100157		K4V26 Set of clamps 4V and connecting rods to retrofit F 260.					●			
8-12100158		K4V56 Set of clamps 4V to retrofit F 560 and F 560 A.			●					
8-12100159		K4V58 Set of clamps 4V to retrofit F 561 and F 562.	●							

OPTIONAL ACCESSORIES FOR HEAVY-DUTY TYRE CHANGERS

PN	Picture	Description	F 565	F 562 - F 562 M	F 560 Special	F 560 A . F 560	F 260	F 240 A	F 230 Mobile	F 226 Mobile
8-12100017		BP 120 Air operated bead presser.	●	●	●	●	●	●	●	●
8-11400034		SGG Tyre paste container with brush (4 kg).	●	●	●	●	●	●		●
801280917		PS56 Additional platform.		●						
8-12120023/90		Runway platform kit H=110.	●							
8-12120020		2.4 Ghz radio remote control kit for F230 Mobile							●	

OPTIONAL ACCESSORIES FOR HEAVY-DUTY TYRE CHANGERS





PN	Picture	Description	F 565	F 562 - F 562 M	F 560 Special	F 560 A . F 560	F 260	F 240 A	F 230 Mobile	F 226 Mobile
8-12120024		Radio Upgrade kit for F230 MOBILE required to install the Radio Kit on machines preceding serial number FPM182480							●	
8-12120008/90		CAR MATE for light vehicles. Supplied with tool head and disc accessory.							●	
8-12120011/90		Roller conveyor.							●	
8-12120009		Extension for loading threshold H=750 mm.							●	
8-12120010		Extension for loading threshold H=1.000 mm.							●	

DIAGRAM OF PACKING SPECIFICATION

PASSENGER CAR TYRE CHANGERS

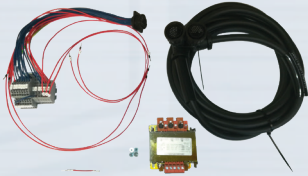

Model	Packing type	Dimensions (cm.) (A x B x H)	Net Weight (kg)	Gross Weight (kg)
M 1032 (versione STD)	Wooden case (A)	115x195x210	500	600
M 928 ROYAL	"	154x114x190	400	490
M 830 LL+KWL	"	132x 76x183	320	365
M 824 2V FS LL	"	90x115x 97	278	305
M 824 LL	"	90x115x 97	263	295
M 624 2V FS	"	99x112x102	260	290
M 624	"	99x112x102	245	275
M 522 2V FS / M 522 FS	"	99x112x102	240	270
M 522 2V / M 522	"	99x112x102	225	255
M 424 2V FS / M 424 FS	"	114x 76x 97	250	275
M 424 2V / M 424	"	114x 76x 97	235	260
M 422 2V FS / M 422 FS	Carton box on pallet base (B)	112x100x 97	225	250
M 422 2V / M 422	"	112x100x 97	215	240

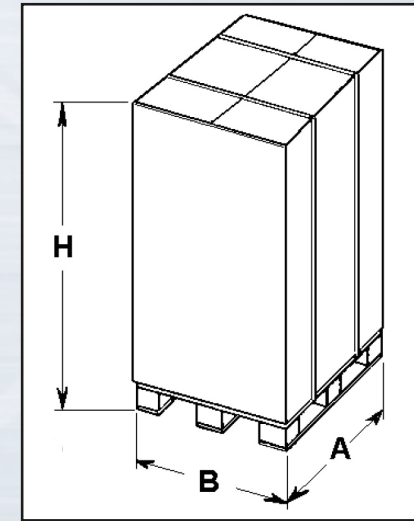
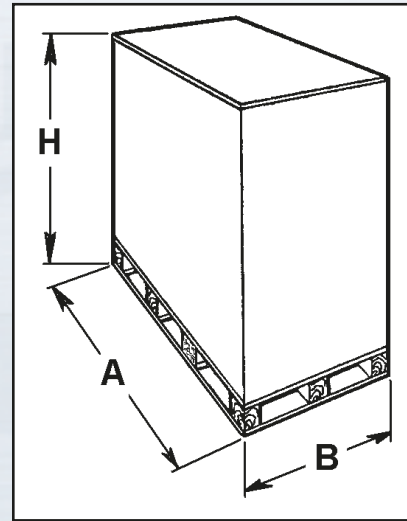
Model	Packing type	Dimensions (cm.) (A x B x H)	Net Weight (kg)	Gross Weight (kg)
M 200 BIKE	"	95x115x108	155	175
Accessory ALLY 80	Carton box on pallet base (B)	47x154x 45	105	120
Accessory ALLY 30 *	"	82x120x 42	70	110
Accessory ALLY 30 **	"	53x120x 42	70	110

* : Accessory with preassembled arm.
** : Accessory without preassembled arm.

DIAGRAM OF PACKING SPECIFICATION

HEAVY-DUTY TYRE CHANGERS

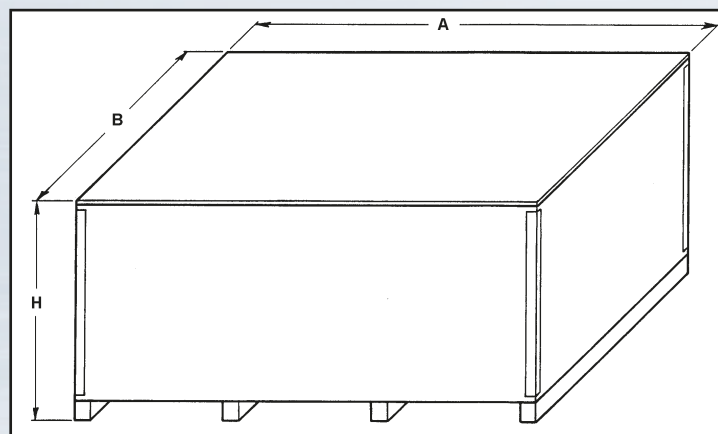

Model	Packing type	Dimensions (cm.) (A x B x H)	Net Weight (kg)	Gross Weight (kg)
F 565	Wooden case	299x229x110	2500	2200
F 562	"	272x231x105	1410	1610
F 560 A	"	212x192x110	750	910
F 560	"	200x172x103	740	870
F 260	"	200x172x103	510	640
F 240 A	"	193x76x109	500	540



in the world

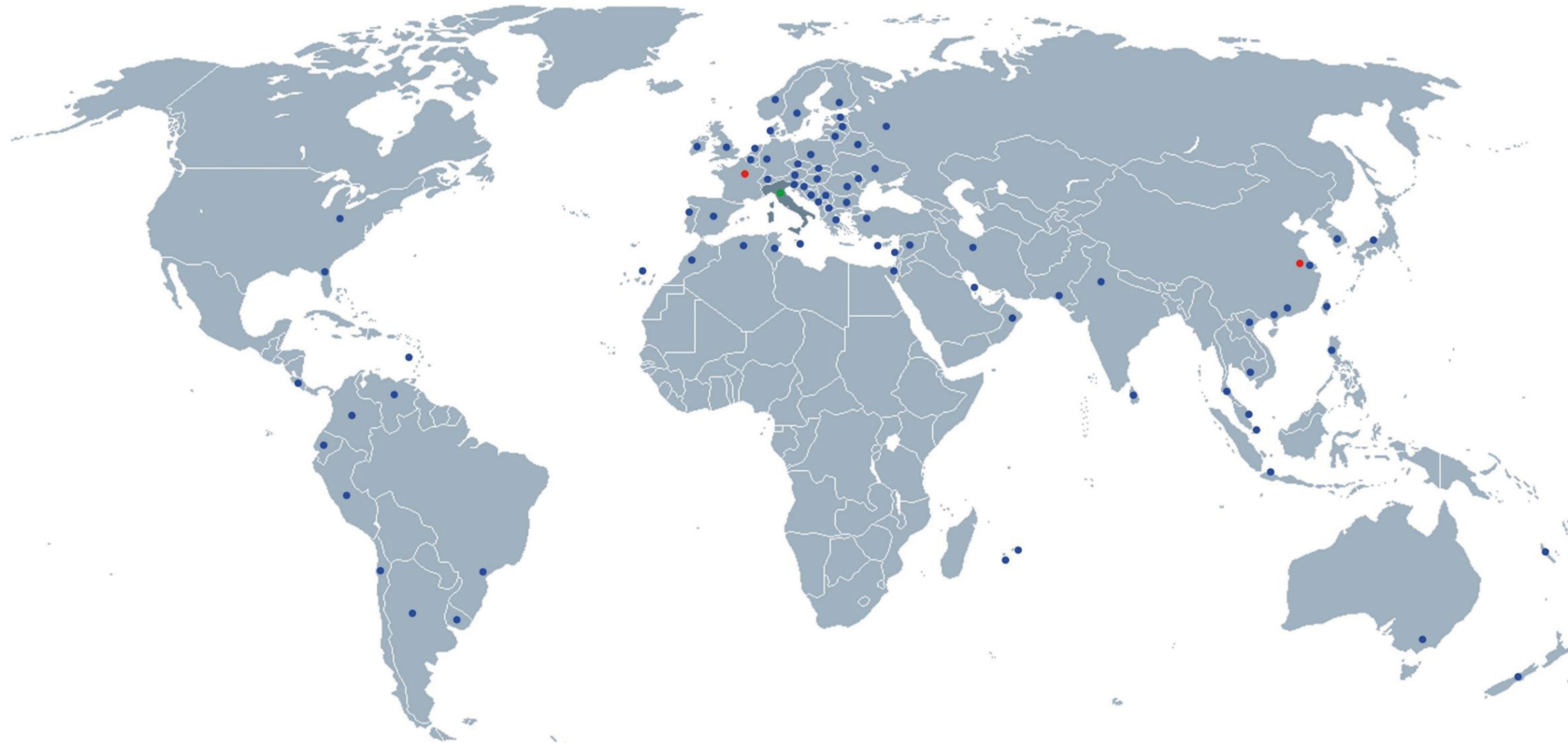

- : HPA-FAIP branch offices in the world.
- : HPA-FAIP distributors.
- : HPA-FAIP head office.

Sales and after-sales network:

- | | | | | | | | |
|-------------|------------------|-----------------|-------------|---------------------|---------------------|----------------------|-------------|
| ● ALGERIA | ● CAMBODIA | ● ECUADOR | ● INDIA | ● MACAO | ● NEW ZEALAND | ● RUSSIAN FEDERATION | ● TAIWAN |
| ● ARGENTINA | ● CANARY ISLANDS | ● ESTONIA | ● INDONESIA | ● MACEDONIA | ● NORWAY | ● SERBIA | ● THAILAND |
| ● AUSTRALIA | ● CHILE | ● FINLAND | ● IRAN | ● MALAYSIA | ● OMAN | ● SINGAPORE | ● TUNISIA |
| ● AUSTRIA | ● CHINA (RP) | ● FRANCE | ● IRELAND | ● MALTA | ● PAKISTAN | ● SLOVAK REPUBLIC | ● TURKEY |
| ● BAHRAIN | ● COLOMBIA | ● GERMANY | ● ISRAEL | ● MARTINICA | ● PERU | ● SLOVENIA | ● UKRAINE |
| ● BELARUS | ● COSTA RICA | ● GREAT BRITAIN | ● JAPAN | ● MAURITIUS | ● PHILIPPINES (THE) | ● SPAIN | ● URUGUAY |
| ● BELGIUM | ● CROATIA | ● GREECE | ● KOSOVO | ● MONTENEGRO | ● POLAND | ● SRI LANKA | ● U.S.A. |
| ● BOSNIA | ● CYPRUS | ● HUNGARY | ● LATVIA | ● MOROCCO | ● PORTUGAL | ● SWEDEN | ● VENEZUELA |
| ● BRAZIL | ● CZECH REPUBLIC | ● HUNGARY | ● LEBANON | ● NETHERLANDS (THE) | ● REUNION ISLAND | ● SWITZERLAND | ● VIETNAM |
| ● BULGARIA | ● DENMARK | ● KOREA (SOUTH) | ● LITHUANIA | ● NEW CALEDONIA | ● ROMANIA | ● SYRIA | |
| ● CAMBODIA | ● ECUADOR | | | | | | |



■ : New or Modified Item

■ : Compatible accessory supplied as STANDARD
● : Compatible accessory supplied on REQUEST

GENERAL SALES CONDITIONS

- The present export price-list, covering standard production equipment, replaces all previous ones.
- Goods are delivered FCA WAREHOUSE CORREGGIO - Incoterms® 2010, ICC Paris and shipped at buyer's cost.
- Standard packing is included in the price of each product.
- When ordering please always state model, quantity, power supply (Voltage, Phases, Hz) required.
- Terms of warranty: 12 months from installation date but no longer than 18 months from the date of NEXION S.p.A. invoice.
- The warranty does not cover defects or damages due to improper installation or use of products, inadequate maintenance or uncomplete knowledge of manuals supplied with the products.
- Any return of goods must always be authorized by NEXION S.p.A. and will be accepted only free our factory, custom cleared. Freight is at sender's risk.
- NEXION S.p.A. reserves the right to change the specifications of the products at any time without prior notice or obligation.

WARNING!

For other conditions please refer to the "Distribution Agreement".



**COMPANY WITH
CERTIFIED
QUALITY SYSTEM
- ISO 9001 -**

